

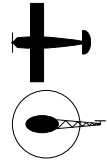

INSTRUCTION MANUAL
FOR AIRPLANE AND
HELICOPTER



XP662

6-CHANNEL COMPUTER RADIO

TABLE OF CONTENTS

I. INTRODUCTION

| | |
|--|----|
| Introduction to the XP662 Radio System | 4 |
| Quick Start (Airplane) | 5 |
| Quick Start (Helicopter) | 7 |
| 1. Using This Manual | 9 |
| 2. Features | 9 |
| 2.1 Transmitter Features | 9 |
| 2.2 Receiver Features | 9 |
| 2.3 Servo Features | 10 |
| 2.4 Servo Layout | 10 |
| 3. Specifications | 11 |
| 3.1 System Specifications | 11 |
| 3.2 Transmitter Specifications | 11 |
| 3.3 Servo Specifications | 11 |
| 3.4 Receiver Specifications | 12 |
| 3.5 Charger Specifications | 12 |
| 3.6 Airborne Battery Pack | 12 |
| 4. Battery Charging | 13 |
| 4.1 Transmitter/Receiver | 13 |
| 4.2 Charger | 13 |
| 5. Trainer System | 14 |

II. AIRPLANE SECTION

| | |
|--|----|
| 1. Transmitter Controls | 15 |
| 1.1 Control Identification and Location | 15 |
| 1.2 Digital Trim Levers | 15 |
| 1.3 Receiver Channel Assignment/Transmitter Throttle ATL | 16 |
| 1.4 Transmitter Rear | 16 |
| 1.5 Control Stick Length Adjustment | 17 |
| 1.6 Direct Servo Control (DSC) | 17 |
| 1.7 Neck Strap Attachment | 17 |
| 2. Connections | 18 |
| 2.1 Installation Requirements | 18 |
| 2.2 Connections | 18 |
| 3. Key Input and Display | 19 |
| 4. Battery Alarm and Display | 19 |
| 5. Input Mode and Function | 20 |
| 5.1 Normal Display | 20 |
| 5.2 Direct Trim Access Display | 20 |
| 5.3 System Mode | 20 |
| 5.4 Function Mode | 21 |
| 5.5 Throttle Cut | 21 |
| 6. Functions (System Mode) | 22 |
| 6.1 Model Type Selection | 22 |
| 6.2 Data Reset | 23 |
| 6.3 Dual Rate Switch Selection | 24 |
| 6.4 Wing Type Selection | 25 |
| 6.5 Model Selection | 27 |
| 6.6 Model Name Entry | 28 |
| 6.7 Modulation Select | 29 |
| 6.8 Fail-Safe/Hold | 30 |
| 6.9 Fail-Safe/Hold Function in Z-PCM Modulation | 30 |
| 6.10 Fail-Safe/Hold Function in S-PCM Modulation | 32 |
| 7. Functions (Function Mode) | 34 |
| 7.1 Servo Reversing | 34 |
| 7.2 Dual Rate | 35 |
| 7.3 Exponential | 36 |
| 7.4 Sub-Trim | 37 |

| | |
|------------------------------------|----|
| 7.5 Travel Adjustment | 38 |
| 7.6 Aileron-to-Rudder Mixing | 39 |
| 7.7 Elevator-to-Flap Mixing | 41 |
| 7.8 Differential | 43 |
| 7.9 Flap-to-Elevator Offset Trim | 44 |
| 7.10 Programmable Mixing (A, B, C) | 45 |

| | |
|---------------|----|
| 8. Data Sheet | 48 |
|---------------|----|

III. HELICOPTER SECTION

| | |
|--|----|
| 1. Transmitter Controls | 49 |
| 1.1 Control Identification and Location | 49 |
| 1.2 Receiver Channel Assignment/Transmitter Throttle ATL | 49 |
| 1.3 Transmitter Rear | 50 |
| 1.4 Control Stick Length Adjustment | 51 |
| 1.5 Direct Servo Control (DSC) | 51 |
| 1.6 Neck Strap Attachment | 51 |
| 2. Connections | 52 |
| 2.1 Installation Requirements | 52 |
| 2.2 Connections | 52 |
| 3. Key Input and Display | 53 |
| 4. Battery Alarm and Display | 53 |
| 5. Input Mode and Function | 54 |
| 5.1 Normal Display | 54 |
| 5.2 System Mode | 54 |
| 5.3 Function Mode | 55 |
| 6. Functions (System Mode) | 56 |
| 6.1 Model Type Selection | 56 |
| 6.2 Data Reset | 57 |
| 6.3 Dual Rate Switch Selection | 58 |
| 6.4 Gear/Gyro Switch Selection | 59 |
| 6.5 Model Selection | 60 |
| 6.6 Model Name Entry | 61 |
| 6.7 Modulation Select | 62 |
| 6.8 Fail-Safe/Hold | 63 |
| 6.9 Fail-Safe/Hold Function in Z-PCM Modulation | 63 |
| 6.10 Fail-Safe/Hold Function in S-PCM Modulation | 65 |
| 7. Functions (Function Mode) | 67 |
| 7.1 Servo Reversing | 67 |
| 7.2 Dual Rate | 68 |
| 7.3 Exponential | 69 |
| 7.4 Sub-Trim | 70 |
| 7.5 Travel Adjustment | 71 |
| 7.6 Throttle Hold | 72 |
| 7.7 Pitch Curve | 73 |
| 7.8 Throttle Curve | 74 |
| 7.9 Revolution Mixing | 75 |
| 7.10 Programmable Mixing (A) | 76 |
| 7.11 CCPM Swashplate mixing | 79 |
| 7.12 CCPM Servo Connections | 80 |
| 7.13 How 120 CCPM works | 81 |
| 8. Data Sheet | 83 |

IV. IMPORTANT INFORMATION

| | |
|--------------------------------|----|
| 1. General Notes | 93 |
| 2. Daily Flight Checks | 93 |
| 3. Warranty Coverage | 94 |
| 4. Repair Service Instructions | 94 |
| 5. Frequency Chart | 95 |

INTRODUCTION TO THE XP662 RADIO SYSTEM • Introduction

Thank you for purchasing the JR XP662 6-Channel Radio System. This unit has been designed to provide the modeler with a high quality, user friendly radio system that can be depended upon for years to come.

It is important that you carefully read this manual before attempting to operate your XP662 System. Please pay particular attention to Page 13, Chapter 4 Charging Your XP662 Radio System, prior to Installing.

AMA INFORMATION

We strongly encourage all prospective and current R/C aircraft pilots join the Academy of Model Aeronautics. The AMA is a non-profit organization which provides services to model aircraft pilots. As an AMA member you will receive a monthly magazine entitled Model Aviation, as well as a liability insurance plan to cover against possible accident or injury. All AMA charter aircraft clubs require

individuals to hold a current AMA sporting license prior to operation of their models. For further information you can contact the AMA at:

Academy of Model Aeronautics
5151 East Memorial Drive
Muncie, IN 47302
(317) 287-1256

XP662 SWITCH FUNCTION DECAL SHEET

Included with the XP662 Radio System is a switch/function decal sheet. These decals have been provided as a guide to specific switch positions, functions, and abbreviations used when operating the XP662.

The four small decals help identify switch positions and

use for helicopter and aircraft modes.

The large decal at the bottom of the sheet gives abbreviations and definitions for all of the aircraft and helicopter functions. The functions decal will prove to be a helpful guide for making program changes to your XP662 both in the shop and at the flying field.

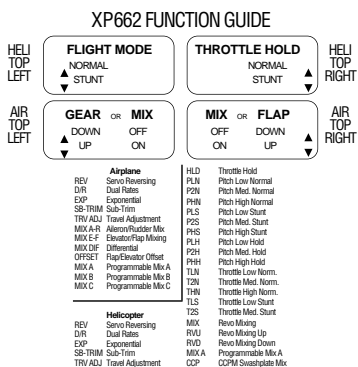

TX BACK
DECAL SHEET

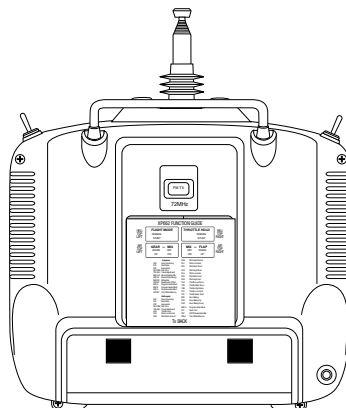

REAR DECAL POSITION
Airplane and Helicopter

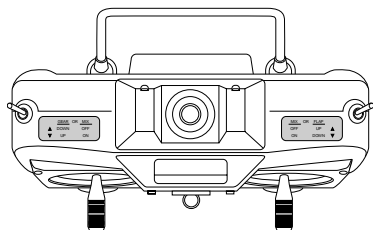

AIRPLANE
DECAL POSITION
Top View (Mode I)

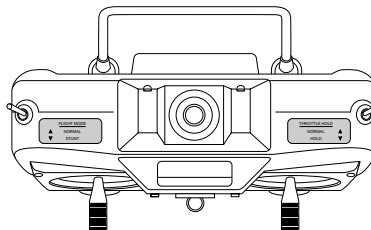

HELICOPTER
DECAL POSITION
Top View (Mode II)

In this manual you will find in-depth instructions that detail all the steps and procedures you should follow in order to program each of the XP662's features. For modelers who want to get into the air fast, we have provided Quick Start. Quick Start covers the basic

programming information necessary to get you airborne. Later, when you want to learn more about specific features of the XP662, turn to the appropriate page(s) in this manual for more detailed programming information.

Model Type Selection

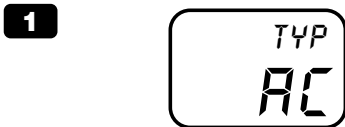

Press the SCROLL and INCREASE buttons simultaneously and hold while turning on the transmitter.



Press the SCROLL button until "TYP" appears on the screen.

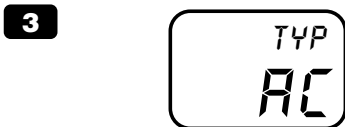

If AC appears on the screen proceed directly to Step 4. If HE appears press the INCREASE or DECREASE button until "AC" appears, then press the SCROLL and INCREASE buttons simultaneously to store the model type change.

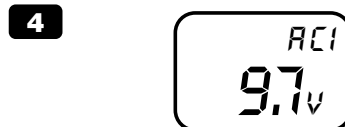

Turn the transmitter off and then on again.

Digital Trim Settings

5 Check to ensure that the aileron, elevator, and rudder trim values are set to the 0 (neutral) position. Next, set the throttle value to the full low (-40) position by pressing the throttle trim lever down.

Servo Reversing

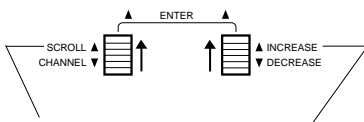

With the transmitter on, press the SCROLL and INCREASE buttons upward simultaneously until a beep is heard.



Press the SCROLL button (if necessary) until "REV-NORM" appears on the screen.

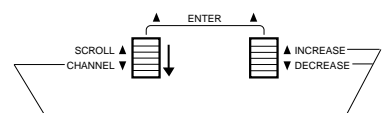

Press the CHANNEL button to select the channel you want to reverse.

Press the INCREASE or DECREASE button to reverse the direction of the channel you selected.



Travel Adjustment

9

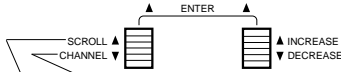

Press the SCROLL button until "TRV ADJ" appears on the screen.

Press the CHANNEL button to select the channel on which you want the travel adjusted.

10

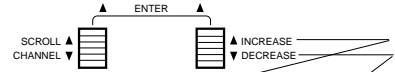

INCREASE
To increase the travel, move the stick (i.e. aileron) to the right then press the INCREASE button to adjust the right travel. Release the INCREASE button and move the same stick to the left. Press the INCREASE button to adjust the left travel.

DECREASE
To decrease the travel, move the stick (i.e. aileron) to the right then press the DECREASE button to adjust the right travel. Release the DECREASE button and move the same stick to the left. Press the DECREASE button to adjust the left travel.

11

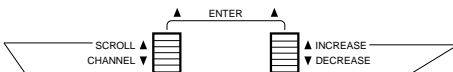
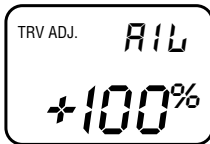

Press the SCROLL and INCREASE buttons upwards simultaneously to return to the main screen and exit the Function mode.

Throttle Auto Cut

12

Before the initial start of your model, please check to ensure that when the THROTTLE CUT button is pressed, the engine's carburetor barrel will move to the fully closed (engine off) position.

This safety feature ensures that the engine can be shut off immediately in case of a problem or safety concern.

Please note that the throttle cut button is only active when the throttle stick is below 1/2 throttle, and a trim value has been added to the throttle trim lever.

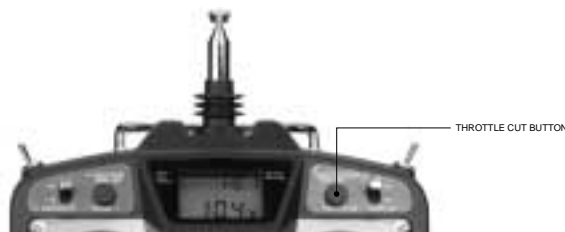

Model Type Selection

1

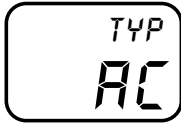

Press the SCROLL and INCREASE buttons simultaneously and hold while turning on the transmitter.

2



Press the SCROLL button until "TYP" appears on the screen.

3

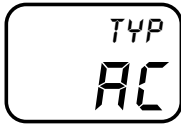

If "HE" appears on the screen, proceed directly to Step 4. If "AC" appears, press the INCREASE or DECREASE button until "HE" appears, then press the SCROLL and INCREASE buttons simultaneously to store the model type change.

4



Turn the transmitter off and then on again.

Digital Trim Settings

5

Check to ensure that the aileron, elevator, and rudder trim values are set to the 0 (neutral) position. Next, set the throttle value to the full low (-40) position by pressing the throttle trim lever down.

Servo Reversing

6

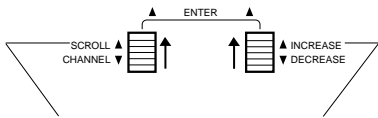

With the transmitter on, press the SCROLL and INCREASE buttons upward simultaneously until a beep is heard.

7

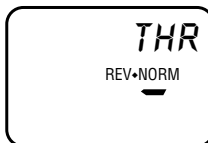

Press the SCROLL button (if necessary) until "REV-NORM" appears on the screen.

8

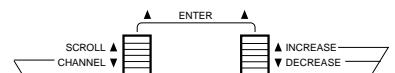

Press the CHANNEL button to select the channel you want to reverse.

Press the INCREASE or DECREASE button to reverse the direction of the channel you selected.



Travel Adjustment

9

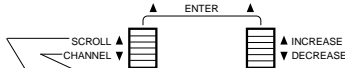

Press the SCROLL button until "TRV ADJ" appears on the screen.

Press the CHANNEL button to select the channel on which you want the travel adjusted.

10

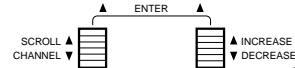

INCREASE
To increase the travel, move the stick (i.e. aileron) to the right then press the INCREASE button to adjust the right travel. Release the INCREASE button and move the same stick to the left. Press the INCREASE button to adjust the left travel.

DECREASE
To decrease the travel, move the stick (i.e. aileron) to the right then press the DECREASE button to adjust the right travel. Release the DECREASE button and move the same stick to the left. Press the DECREASE button to adjust the left travel.

Pitch Curve

11

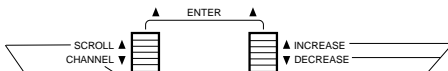
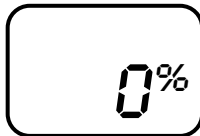

Press the SCROLL button until "PLN" appears on the screen.

Press the CHANNEL button to select stick position (point location).

Press the INCREASE or DECREASE button to adjust the point value at the selected stick position.

12

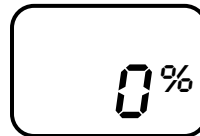

STICK POSITION (POINT LOCATION)
L = Low
2 = Center
H = High

PRESET VALUES
L = 0%
2 = 50%
H = 100%

RECOMMENDED INITIAL PITCH SETTINGS
(Please refer to your helicopter kit instruction for pitch settings if available)
L = 0° Pitch
2 = 5° Pitch
H = 9° Pitch

Throttle Auto Cut

13

Before the initial start of your model, please check to ensure that when the THROTTLE CUT button is pressed, the engine's carburetor barrel will move to the fully closed (engine off) position.

This safety feature ensures that the engine can be shut off immediately in case of a problem or safety concern.

Please note that the THROTTLE CUT button is only active when the throttle stick is below 1/2 throttle, and a trim value has been added to the throttle trim lever.

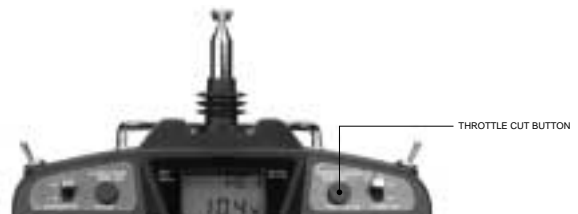

1

USING THIS MANUAL

The XP662 is a full feature introductory computer radio for airplanes and/or helicopters. This manual is divided into two main sections: airplanes and helicopters. You need only refer to the section that pertains to the type of model you are programming—e.g., if you are programming your XP662 for helicopters, follow the instructions in the helicopter section.

Blank data sheets are included at the end of both sections. Once you have input all the necessary data into your transmitter for a particular model, we strongly recommend that you immediately write that information down on a copy of the data sheet provided. This is to insure that, in the rare case of a memory failure, you will not lose your data.

CHAPTER 2: FEATURES

2.1

TRANSMITTER FEATURES

Airplane and Helicopter Mode

- Easy-to-read LCD screen
- 6-model name entry
- 6-model memory
- Dual rates on aileron and elevator
- Dual rates can be combined on one switch
- Exponential rate on aileron and elevator
- Trainer system compatible with most JR radios
- Easy-access programming buttons
- Computer designed ergonomically styled case
- Adjustable stick length
- Throttle trim only affects idle position
- Two speed scrolling; press and hold the appropriate button to scroll quickly or press and release to scroll in steps
- FM/PCM selectable
- Fail-safe/fail-safe memory (PCM only)
- Digital trims for precise adjustment

Airplane Mode

- Aileron to rudder mixing
- Elevator to flap mixing
- Flap to elevator mixing
- Flaperons mixing
- Delta wing mixing
- Aileron differential
- V-tail mixing
- Three programmable mixes
- Mixing differential

Helicopter Mode

- Two 3-point throttle curves
- Two 3-point pitch curves (three when throttle hold is activated)
- Flight mode switch can combine throttle curve, pitch curve, dual rates, and gyro sensitivity
- Throttle hold
- Revolution mixing up and down
- Programmable mixing
- Optional 120° CCPM Swashplate mixing
- Separate trim setting for all flight modes

2.2

RECEIVER FEATURES

R700 Slimline Receiver

- The R700's extremely compact "slimline" design allows it to fit easily in limited spaces.
- An independent laboratory ranked the R700 Receiver with JR's patented ABC&W circuitry as one of the best receivers ever tested in terms of 3IM, 2IM, signal-to-noise ratio, adjacent channel rejection, and on-channel capture point.
- The R700 is compatible with all JR FM transmitting radios.
- A special "unwanted interference limiter" ignores signals outside of the R700's band width when the receiver is on and the transmitter is off. The limiter also prevents servos from random glitching when other transmitters are operating in close proximity.
- The electrical circuitry is state-of-the-art surface mount technology (SMT). These SMT components draw less current, thus increasing flying time. Flush mounting of these components also reduces the risk of vibration, wear, and damage.

2.3 SERVO FEATURES

537 Servo

- An ultra-tight deadband amplifier ensures accurate neutral centering
- Low-current drain
- Ball bearing supported output shaft with new wide spacing for improved precision
- An indirect drive feedback potentiometer gives additional protection from vibration

2.4 SERVO LAYOUT

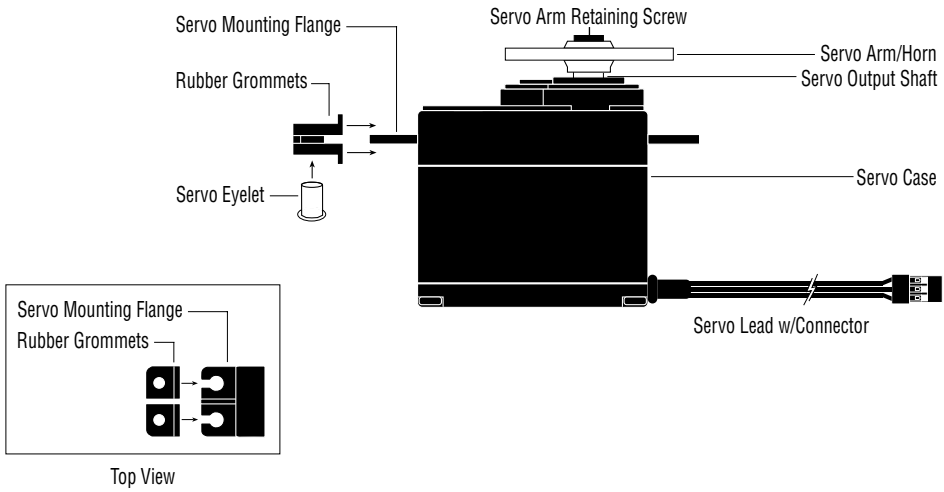

3.1 SYSTEM SPECIFICATIONS

| TYPE | AIRPLANE | HELICOPTER |
|------------------|---|---|
| SYSTEM NAME | XP662A | XP662H |
| TRANSMITTER BODY | NET-XP662A | NET-XP662H |
| RECEIVER | R700 | R700 |
| CHARGER | NEC-221 | NEC-222 |
| AIRBORNE BATTERY | 4N-600 | 4N-1000 |
| SERVOS | NES-537BBX4 | NES-537BBX5 |
| ACCESSORIES | Mini Switch 12" Aileron Extension Servo Accessories Instruction Manual Function Guide | Mini Switch 12" Aileron Extension Servo Accessories Instruction Manual Function Guide |

3.2 TRANSMITTER SPECIFICATIONS

| TYPE | AIRPLANE | HELICOPTER |
|---------------|----------------------------|----------------------------|
| MODEL NUMBER | NET-XP662A | NET-XP662H |
| ENCODER | 6-Channel Computer System | 6-Channel Computer System |
| RF | 50/72MHz | 50/72MHz |
| MODURATION | PPm (FM), PCM (S,Z) | PPm (FM), PCM (S,Z) |
| OUTPUT POWER | Approximately 1 Watt | Approximately 1 Watt |
| CURRENT DRAIN | 200mA | 200mA |
| POWER SOURCE | 1.2Vx8 Ni-Cd (9.6V) 600mAh | 1.2Vx8 Ni-Cd (9.6V) 600mAh |
| OUTPUT PULSE | 1000-2000 (1500 Neutral) | 1000-2000 (1500 Neutral) |

3.3 SERVO SPECIFICATIONS

| TYPE | 537BB |
|-----------------------|--------------------|
| TORQUE (oz/in) | 43 oz |
| SPEED | .25 |
| WEIGHT | 1.37 |
| SIZE (in) (W x L x H) | 0.73 x 1.52 x 1.32 |
| BB | YES |
| MOTOR | 3-Pole Ferite |

3.4 RECEIVER SPECIFICATIONS

| TYPE | R700 FM |
|----------------------------|---|
| MODEL NUMBER | NER-700 |
| TYPE | 7-Channel/FM Slimline ABC & W Circuitry |
| FREQUENCY | 50/72MHz |
| SENSITIVITY (Microseconds) | 5µs Minimum |
| SELECTIVITY | 8KHz/50dB |
| WEIGHT(oz) | 0.64 oz |
| SIZE(in) (W x L x H) | 1.84 x 0.98 x 0.16 |
| RECEIVER ANTENNA | 39" For All Aircraft Frequencies |

3.5 CHARGER SPECIFICATIONS

| TYPE | AIRPLANE | HELICOPTER |
|----------------|-------------------|-------------------|
| MODEL NUMBER | NEC-211 | NEC-222 |
| INPUT VOLTAGE | AC 100-120V | AC 100-120V |
| OUTPUT CURRENT | 50mAh TX/50mAh RX | 50mAh TX/150mAhRX |
| CHARGING TIME | 15 Hours | 15 Hours |

3.6 AIRBORNE BATTERY PACK

| TYPE | AIRPLANE | HELICOPTER |
|-----------------------|--------------------|--------------------|
| MODEL NUMBER | 4n-600 | 4N-1000 |
| VOLTAGE | 4.8V | 4.8V |
| SIZE (in) (W x L x H) | 2.24 x 0.59 x 2.05 | 2.60 x 0.63 x 1.70 |
| WEIGHT (oz) | 3.3 | 4.9 |

4.1 TRANSMITTER/RECEIVER

It is imperative that you fully charge both the transmitter and the receiver battery packs prior to each day of flying. For the initial charge, leave the charger and batteries hooked up for 20–24 hours in order to fully charge both battery packs to peak capacity. For subsequent charges, leave the charger and batteries hooked up overnight (approximately 16 hours).

The charger supplied with this system is designed to recharge your transmitter battery at a rate of 50mA. The receiver battery pack will charge at 50mA for the 600mAh airplane battery pack and at 150mA for the 1000mAh helicopter battery pack.

Transmitter Only

The center pin on all JR remote control systems is **negative**. Therefore, the center pin on all JR chargers is negative, not positive. This is different from any other manufacturers' chargers and radio systems. Beware of improper connections based on "color code" wire leads, as they do **not** apply in this instance. You must make certain that the center pin of your JR transmitter is always connected to the negative voltage for correct polarity hookup.

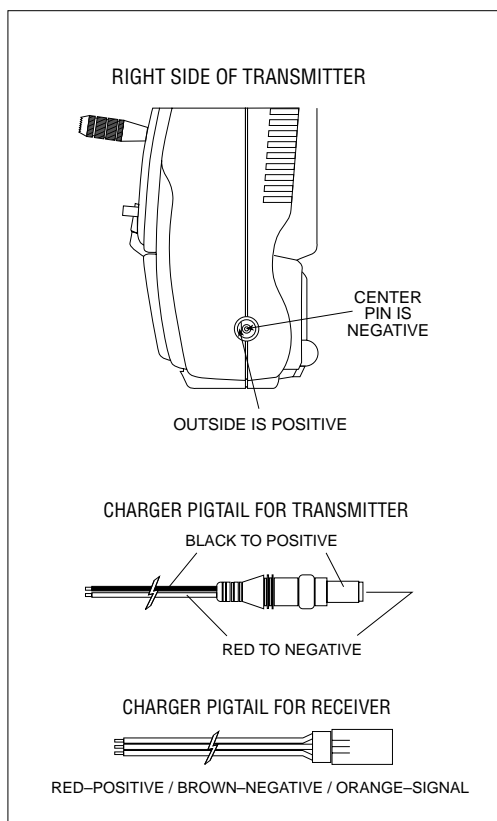

4.2 CHARGER

The pilot lamps should always be on during the charging operation. If they are not, check to make sure you have turned off both the transmitter and receiver.

Do not use the charger for equipment other than JR. The charging plug polarity may not be the same and equipment damage may result.

Do not use other manufacturers' after-market accessories that plug into the transmitter's charging jack. If you do, any damage that results will not be covered by warranty. If you are unsure of compatibilities with your radio, seek expert advice before doing anything to avoid possible damage. During the charging operation, the charger's temperature is slightly elevated. This is normal.

5

TRAINER SYSTEM

The XP662 features a built-in trainer system. The transmitter can be used as either a master (trainer) or as a slave (trainee). The XP662 is compatible with all

other current JR radios that have built-in trainer systems. An optional Trainer Cord (JRPA130) is needed .

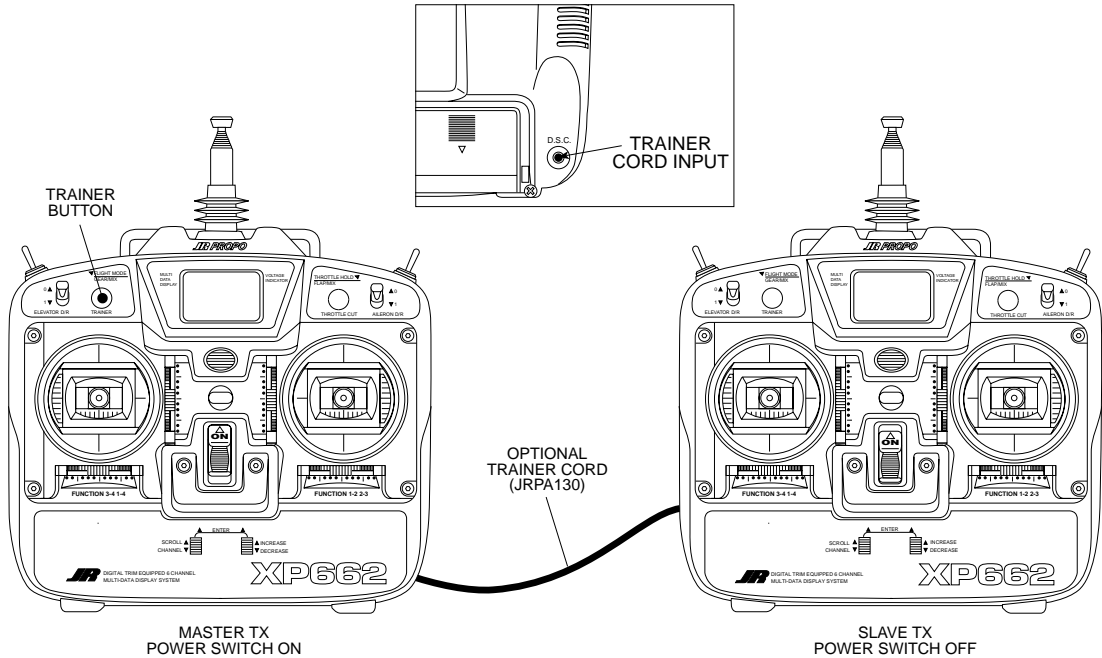

Operating the Trainer System

1. Match the servo reversing and trims of both radios.
2. Plug the optional trainer cord into both transmitters.
3. Turn on the master transmitter.
(Note: The slave radio must be left off.)
4. Test all the control functions on your aircraft with the master radio.
5. Push the trainer button on the master transmitter and check all the control functions with the slave radio.

1.1 CONTROL IDENTIFICATION AND LOCATION • Mode II

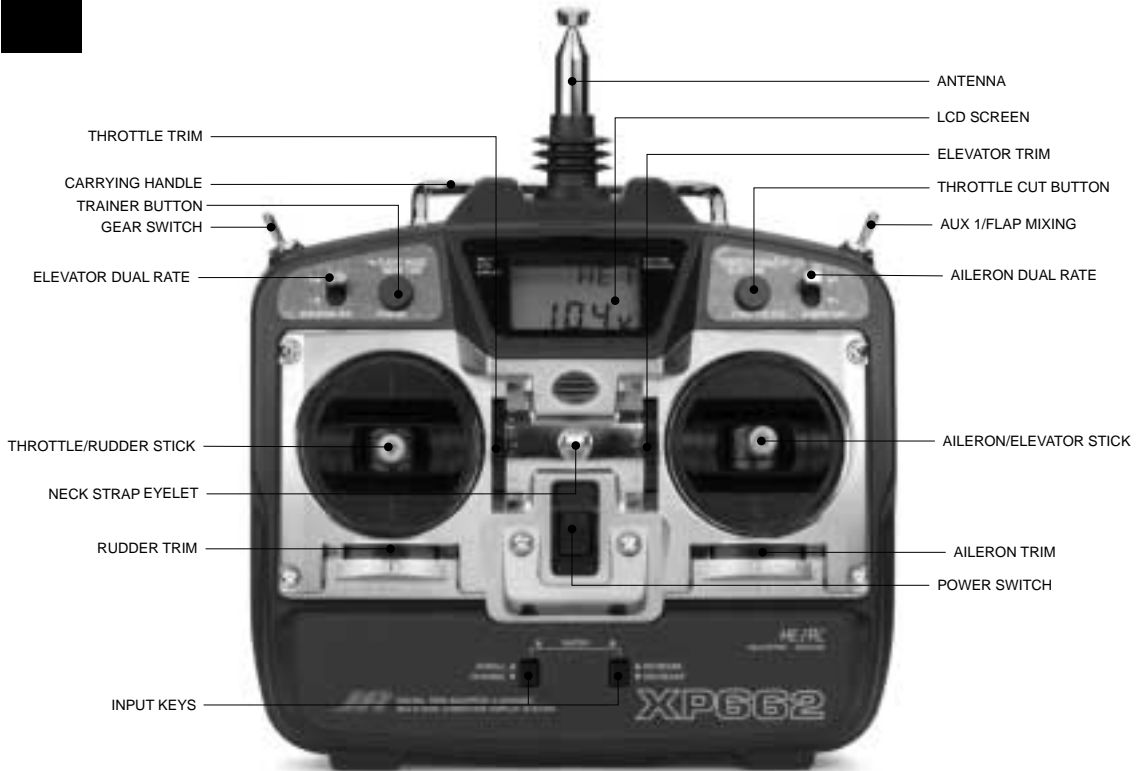

1.2 DIGITAL TRIM LEVERS

The XP662 features four digital trim levers with a direct trim display feature for ultra precise adjustments. When a trim input is given, the display screen will automatically change to show the trim value for current channel being adjusted. Once the trim change has been completed, the screen will automatically return to the previous screen display after 2–3 seconds.

A significant feature found only with Digital Trims is the ability for the XP662 to automatically store the trim values in the system memory. This eliminates the need for previously found software functions like

Trim Offset Memory, Rudder Offset Memory (Heli), and Stunt Trim (Heli).

In Heli mode, the XP662's digital trims provide a separate set of trim values for each Flight mode (Normal, Stunt, and Throttle Hold), which takes the place of the previously needed Stunt Trim function. With this feature, the trim levers are active in all flight modes, and will store the trim values for each mode independantly. This feature also takes the place of the previously needed rudder offset function, since there is now a completely separate set of trim setting for the Throttle Hold mode.



1.3

RECEIVER CHANNEL ASSIGNMENT/TRANSMITTER THROTTLE ALT

1. THRO Throttle Channel
2. AILE Aileron Channel
3. ELEV Elevator Channel
4. RUDD Rudder Channel
5. GEAR Gear Channel
6. AUX I Auxiliary I Channel (Flap)

Transmitter Throttle ALT

The Throttle ALT function makes the throttle stick trim active only when the throttle stick is less than half throttle. This gives easy, accurate idle adjustments without affecting the high throttle position.

1.4

TRANSMITTER

Note: Your transmitter has a 5-year lithium battery to protect your pre-programmed data against main transmitter battery failure. If your system reads 0.0 volts or has an unfamiliar display (service mode)

or your data resets to the factory defaults, return your transmitter to Horizon Service Center (see page 85) for lithium battery replacement.



BATTERY CONNECTOR
Use caution when disconnecting/removing the transmitter battery pack as if the connector is not properly disconnected, damage to the connector and/or the radio system can result.

Transmitter Crystal Replacement Notice

The Federal Communications Commission (FCC) requires that changes in transmitter frequency must be performed only by an authorized service technician (Horizon Service Center). Any transmitter frequency change made by non-certified technician may result in a violation of the FCC rules.



1.5 CONTROL STICK LENGTH ADJUSTMENT

To adjust the control stick length, use a 2mm Allen wrench to unlock the set screw located inside the end of the control stick. Turn the set screw counterclockwise to loosen it, then turn the knurled portion of the stick to adjust the length. Counterclockwise will lengthen the stick and clockwise will shorten it. After the control stick(s) has been adjusted to suit your flying style, tighten the set screw.

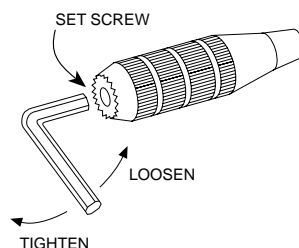

1.6 DIRECT SERVO CONTROL (DSC)

For proper DSC hook-up and operation:

1. Leave the transmitter power switch off. The transmitter will not transmit any radio frequency (RF) in this position.
2. Plug the optional DSC Cord (JRPA132) into the DSC port in the rear of the transmitter.
3. The encoder section of the transmitter will now be operational and the LCD display will be lit.
4. Plug the other end of the DSC Cord into the receiver charge receptacle. Turn on the switch harness.

Note: When installing the optional charging jack (JRPA024), be sure to hook the charging jack receptacle securely into the switch harness charge cord.

Why you should use the DSC function:

1. The DSC enables you to check the control surfaces of your airplane without drawing the fully operational 200mAh from your transmitter battery pack. Instead, you will only draw 70mAh when using the DSC function.

Note: You will need to purchase (separately) both the DSC Cord (JRPA132) and the JR Deluxe Switch Harness (JRPA001) to make use of the XP662 DSC function.

2. The DSC function allows you to make final adjustments to your airplane or helicopter without transmitting any radio signals. Therefore, if another pilot is flying on your frequency, you can still adjust your aircraft and not interfere with the other aircraft.

Note: Under no circumstances should you attempt to fly your aircraft with the DSC Cord plugged in! This feature is for bench checking your aircraft only.

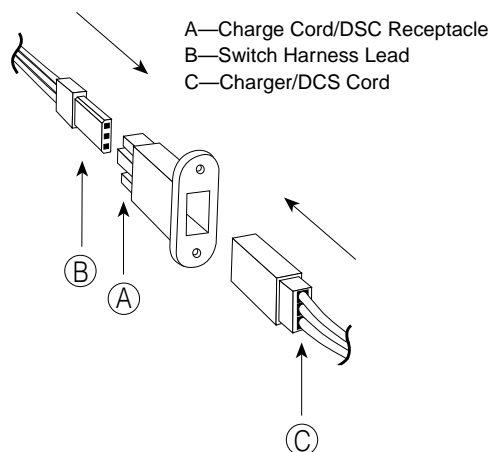

1.7 NECK STRAP ATTACHMENT

There is an eye hook on the front of the transmitter for attaching an optional neck strap (JRPA023). The eye hook is precisely positioned (see Section 1.1)

so that the transmitter will be perfectly balanced when a neck strap is used.



2.1 INSTALLATION REQUIREMENTS

Please read and carefully follow these suggestions.

1. For added protection, wrap the RX and the RX Ni-Cd in foam rubber that is at least 1/4" thick.
2. Run the RX antenna through the fuselage and make sure it is fully extended. Never cut or bundle your RX antenna—this will decrease range and performance.
3. Rubber servo grommets are included with your radio system and should be installed in the servo flanges. The servos should then be mounted on either hardwood rails or a plywood tray with the mounting screws provided. **Do not overtighten the mounting screws.** The flange of the brass eyelets should face down (toward the wood).
4. All servos must be able to move freely over the full range of their travel. Make sure the linkages do not impede servo travel. A stalled servo will drain the battery pack within a few minutes.
5. Before installing servo output arms, make sure the servo is in its neutral position.
6. In the case of gas-powered model aircraft, mount the receiver power switch on the side of the fuselage opposite the muffler to protect the switch from exhaust residue. With other types of models, mount the switch in the most convenient place. Make sure that the switch operates freely and is capable of traveling its full distance.
7. **With your model sitting on the ground and the transmitter antenna collapsed, check that your system works at a distance of 75 to 100 feet.**

If your system stops functioning at a distance that is shorter than listed above, please contact the Horizon Service Center for further information prior to flying your model.

2.2 CONNECTIONS

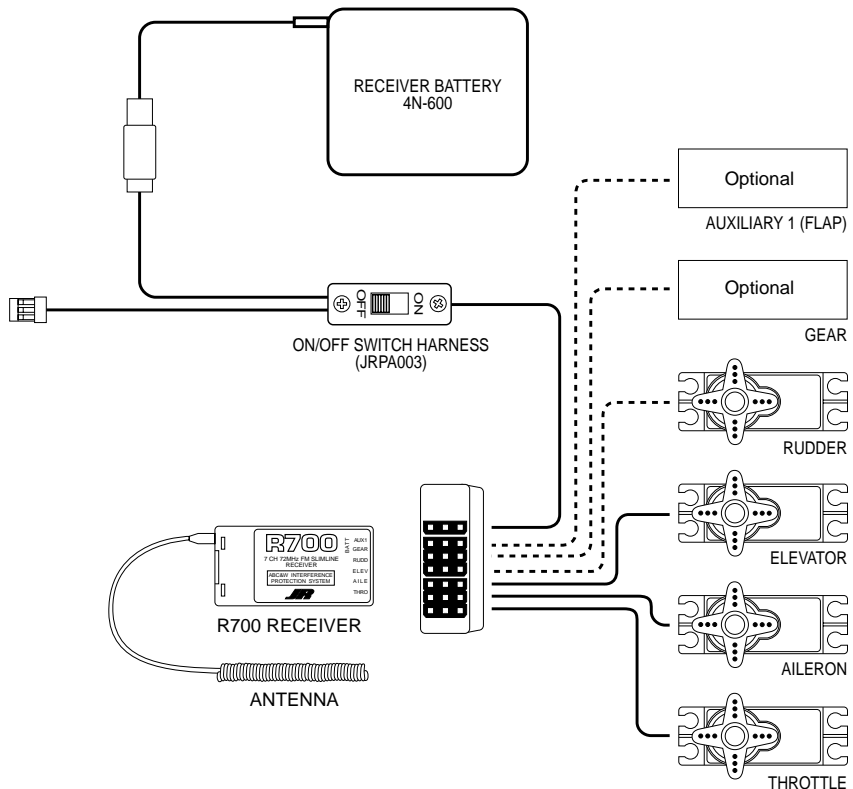

3

KEY INPUT AND DISPLAY

Two input keys are located at the lower right and left faceplate of the XP662 transmitter. The keys are used to access and program the transmitter. Each key can be moved up or down using your thumbs.

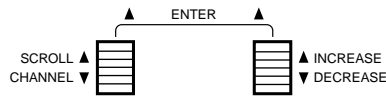

Left button up.....SCROLL — Used to advance through the menus
Left button down...CHANNEL — Used to advance through the channels or features in a given function

Right button up.....INCREASE — Increases value or changes setting (e.g., Reverse Normal)
Right button down...DECREASE — Decreases value or changes setting (e.g., Reverse Normal)

CHAPTER 4: BATTERY ALARM AND DISPLAY • Airplane

4

BATTERY ALARM AND DISPLAY

When the transmitter battery drops below 9.0 volts, the display will start to flash "BAT" and an audible alarm will sound for eight beeps. These warnings mean you should land your aircraft immediately.

Note: During the period that the battery alarm is flashing, the input buttons will not function. If you are currently in the function mode, the transmitter will exit automatically and return to the normal display (see Section 5.1).

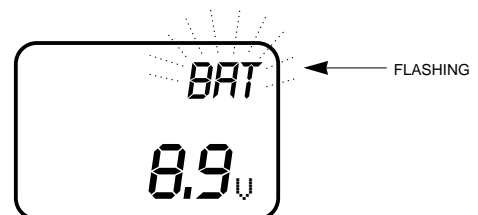

5.1 NORMAL DISPLAY

When the power switch is turned on, the screen will read as shown here in the diagram. This screen is referred to as the normal display.

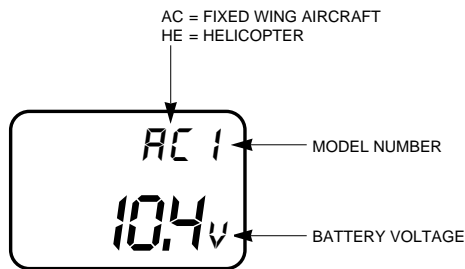

5.2 DIRECT TRIM ACCESS DISPLAY

The Direct Trim function of the XP662 can be accessed through the use of any of the four digital trims levers (throttle, aileron, elevator, or rudder).

When a trim input is given, the screen will automatically change to show the trim value for that particular channel. Once the trim adjustment has been made, the screen will automatically return to the previous screen setting after 2–3 seconds. The maximum trim value for each channel is +/- 40 in increments of 2.

5.3 SYSTEM MODE

To enter the system mode, press the SCROLL and INCREASE buttons simultaneously while you turn on the transmitter. You can now select any of 7 system mode functions shown here in the flow chart. To exit the system mode, press the SCROLL and INCREASE buttons simultaneously or turn off the transmitter. Press the SCROLL button to move through the system mode functions. Information for each function is located on the page number listed next to the function name.

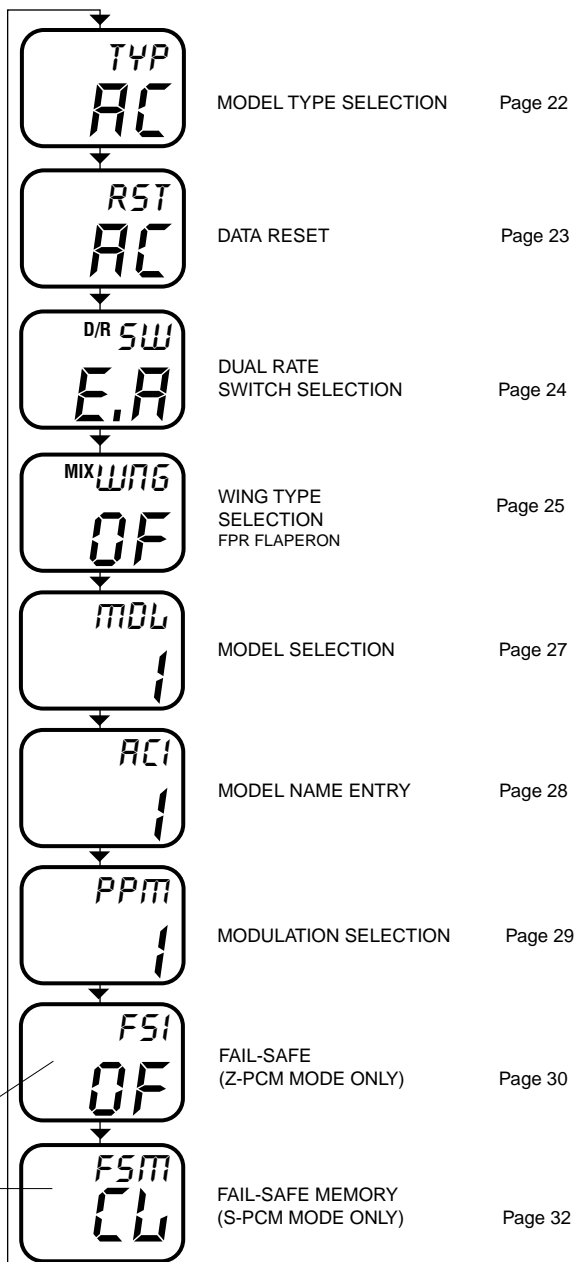

Only visible when S or Z PCM modulation is selected



5.4 FUNCTION MODE

To enter the Function mode, turn on the transmitter. Press the MODE and CHANNEL buttons simultaneously until a beep is heard. The display will change accordingly and show the last active function. Press the MODE button to scroll down through the functions one by one as shown in the flowchart below. Once the appropriate function is selected, use the CHANNEL button to select the appropriate channel. Use the INCREASE and DECREASE buttons to adjust the values displayed on the screen.

5.5 THROTTLE CUT

Your XP662 incorporates a special THROTTLE CUT button located on the upper right face of the transmitter. This feature is designed to immediately override any current throttle/trim position and will immediately return the throttle servo to the full low position. This feature will allow the engine to be automatically stopped in case of emergency, or in the event of a crash. When adjusting your throttle linkage, please check to ensure that when the THROTTLE CUT button is pushed, the throttle servo will move the carburetor barrel to the full closed position.

Note: In some cases it will be necessary to adjust the engines barrel stop screw so that the carburetor can be fully closed. Please refer to your engine instructions for more detail.

The Throttle Cut function is designed to function only which the throttle stick is below the 1/2 position, and a trim value has been assigned to the throttle trim levers.

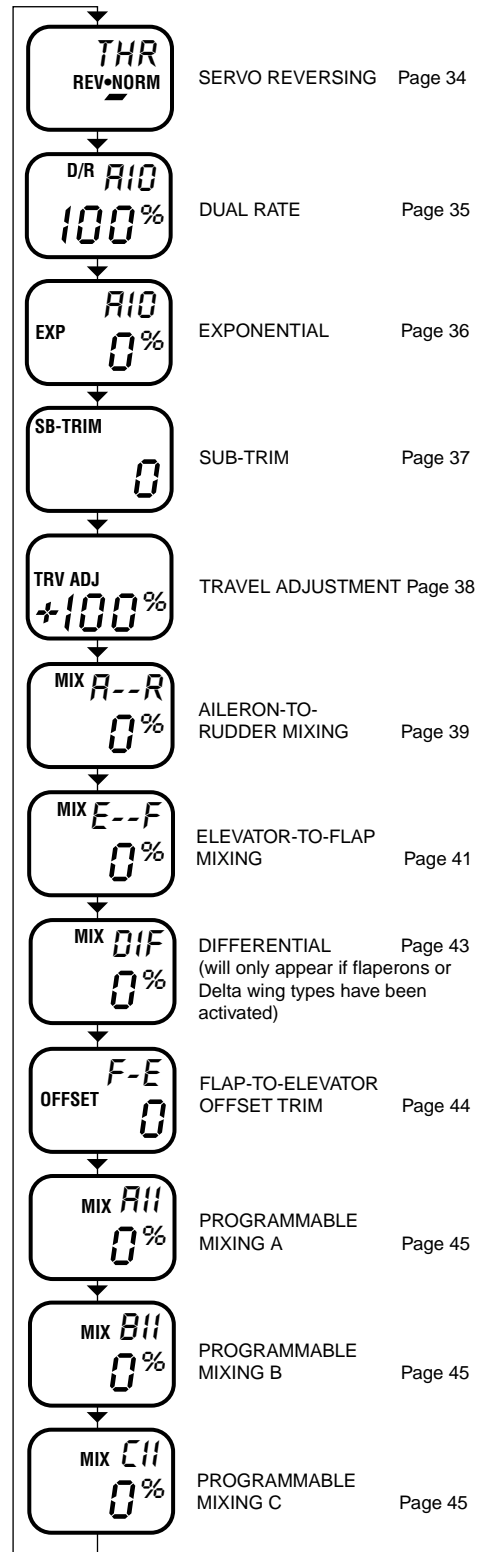

6.1 MODEL TYPE SELECTION

Two types of aircraft programming are available with the XP662, airplane (AC) and helicopter (HE). When you enter the model type selection function, the current model type will appear on the screen. (The current model type being the factory preset or the last model used.) When you press the INCREASE or DECREASE button to change the model type, the

new model type indicated on the screen will flash. For example, if the current model type is AC and you change to HE, "HE" will flash on the screen. The flashing alerts you to the change of model type and will stop once you move to the next function or exit the system mode.

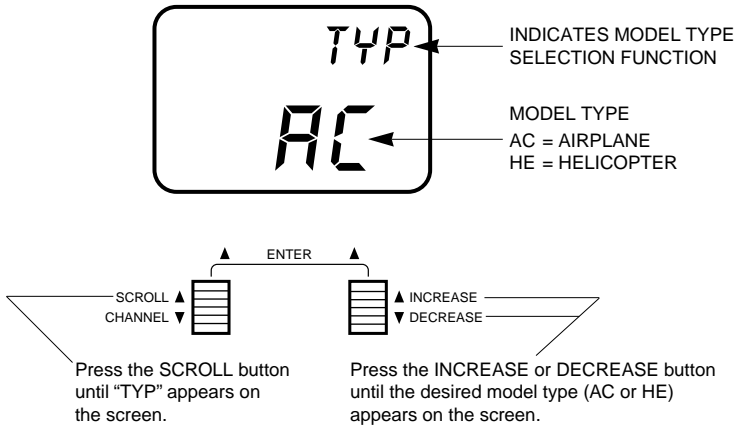

Accessing the Model Type Selection Function

1. Press the SCROLL and INCREASE buttons simultaneously and hold.
2. Turn on the transmitter to enter the system mode.
3. Press the SCROLL button until "TYP" appears on the screen.
4. Press the INCREASE or DECREASE button until the desired model type appears on the screen (AC = airplane HE = helicopter).
5. Press the SCROLL button to access the Data Reset function.
6. To exit, press the SCROLL and INCREASE buttons simultaneously.



6.2 DATA RESET

The data reset function allows you to reset all the programming in the selected model (1–6) to the factory settings. Before using the Data Reset function, it's important to enter the model selection

function and select the desired model number (1–6) for which you want to reprogram to the factory settings. The model selection function is described in Section 6.2.

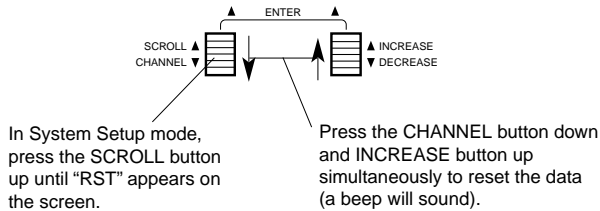
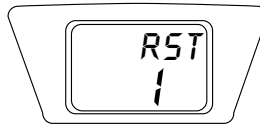
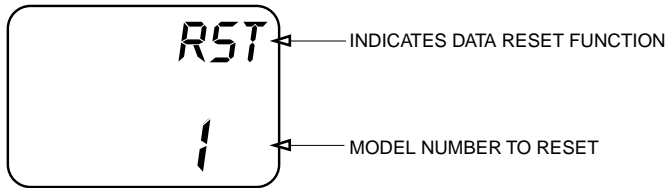

Accessing the Data Reset Function

1. Press the SCROLL and INCREASE buttons up simultaneously and hold.
2. Turn on the transmitter to enter the System mode.
3. Press the SCROLL button up until "RST" appears on the screen.
4. Press the CHANNEL and INCREASE buttons simultaneously to reset the data. (To confirm that the selected model's programming has been reset, a beep will sound and the model number will momentarily disappear from the screen.)
5. Press the SCROLL button to access the Model Select function.
6. To exit, press the SCROLL and INCREASE buttons up simultaneously.



6.3

DUAL RATE SWITCH SELECTION

The dual rate switch position is selectable and the elevator and aileron dual rates can be combined on one switch. This allows a single switch to be used when moving from high rates for wild maneuvers to low rates for mild maneuvers. Exponential Rate (EXP) is also available for both aileron and elevator

and works in conjunction with the dual rate function to provide mild control movements around neutral while allowing maximum servo travel. This reduces sensitivity in the middle portion of the stick control and still allows full travel at the end of the stick control. Refer to section 7.3 for exponential rate adjustment.

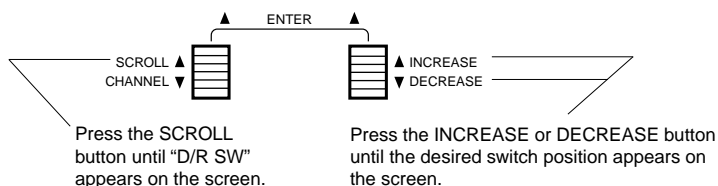
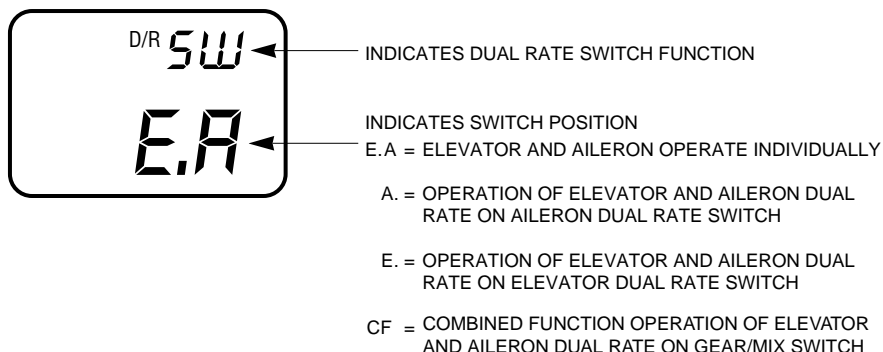

Accessing the Dual Rate Switch Selection Function

1. Press the SCROLL and INCREASE buttons simultaneously and hold.
2. Turn on the transmitter to enter the system mode.
3. Press the SCROLL button until "D/R SW" appears on the screen.
4. Press the INCREASE or DECREASE button until the desired switch position appears on the screen.
5. Press the SCROLL button to access the Wing Type selection function.
6. To exit, press the SCROLL and INCREASE buttons simultaneously.



6.4

WING TYPE SELECTION

Flaperon, V-tail, and Delta Mixing are available for specialty aircraft that require those functions. The flaperon feature mixes flaps with ailerons so the ailerons can be drooped for takeoffs and landings while still functioning fully as ailerons. V-Tail Mixing combines rudder and elevator for V-Tail operations. The Delta Wing function allows the aileron to also act as the elevator, while retaining independent use of both functions. The Delta Wing function allows the ailerons to also act as the elevator, while retaining independent use of both functions.

Flaperon Setup

When using flaperon mixing, two servos (one for each aileron) must be used. Connect the left aileron servo to channel #6 (Aux 1) and the right aileron servo to channel #2 (Aile) in the receiver. Individual functions (e.g., servo reversing, sub-trims, etc.) are still available for each of the channels. Use sub-trims for individual neutral adjustment. Adjust the aileron travel values by increasing or decreasing the aileron dual rate. Flap adjustments are made with flap left/right travel adjustment described in Section 7.5. Also see Aileron Differential in Section 6.18.

V-Tail

V-Tail Mixing requires two servos. Connect the left tail servo to channel #3 (Elev) and the right tail servo to channel #4 (Rudd) in the receiver. Individual functions (e.g., servo reversing, sub-trims, etc.) are available for each servo. Use sub-trims for individual neutral adjustments described in Section 7.4. V-Tail elevator travel is adjusted by elevator dual rates described in Section 7.2.

Delta-Wing Mixing

Delta or Elevon Mixing as it is commonly known, is the final wing mixing selection in your XP652. This style of aircraft also employs two wing servos. However, in essence, there is not an elevator present. Instead, at an elevator stick input, the two wing servos function in conjunction with one another in the same direction to create an up/down movement of the aircraft. Also, when an aileron control is given, the two wing servos move in opposite directions to function as ailerons as well.

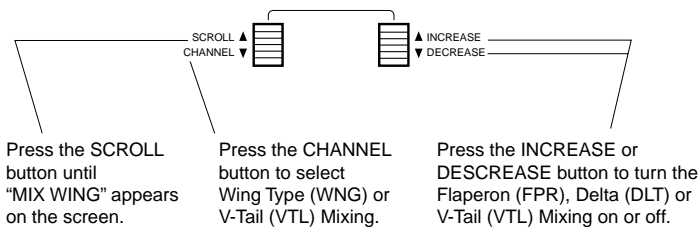

OF = OFF
ON = ON

INDICATES WING TYPE FUNCTION
FPR = FLAPERON
VTL = V-TAIL
DLT = DELTA
WING = WING TYPE SELECTION

Accessing the Wing Type Selection Function

1. Press the SCROLL and INCREASE buttons up simultaneously and hold.
2. Turn on the transmitter to enter the System mode.
3. Press the SCROLL button until the "MIX WNG" appears on the screen.
4. Press the CHANNEL button to select either the Wing Type (WNG) or V-Tail (VTL) mode.
5. Press the SCROLL button to access the Model Name function.
6. To exit, press the SCROLL and INCREASE buttons up simultaneously.



6.4 WING TYPE SELECTION (continued)

To Activate Flaperon (FPR) Mixing (Wing Type Mode)

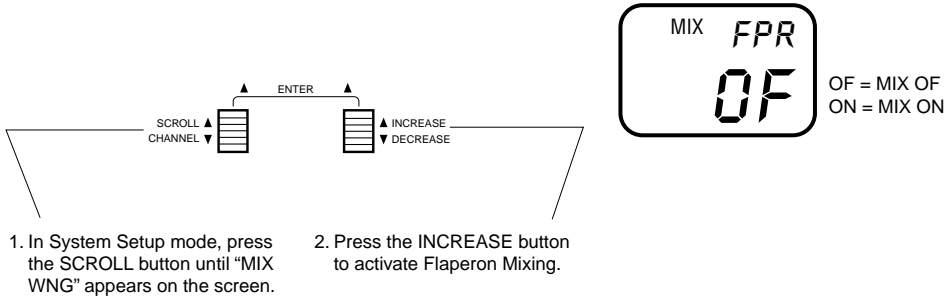

To Activate Delta-Wing (DLT) Mixing (Wing Type Mode)

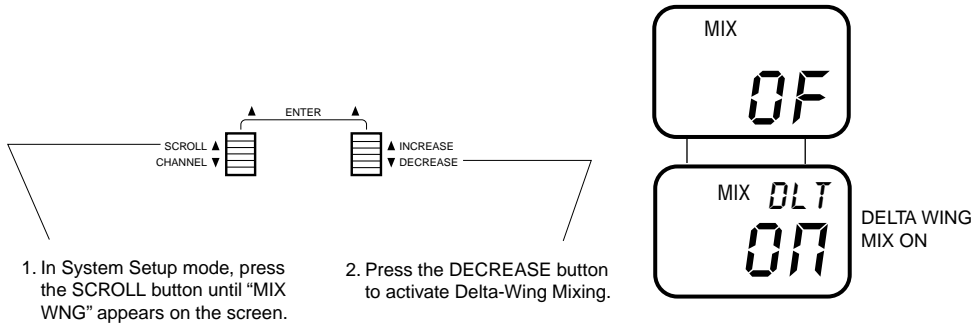

To Activate V-Tail (VTL) Mixing

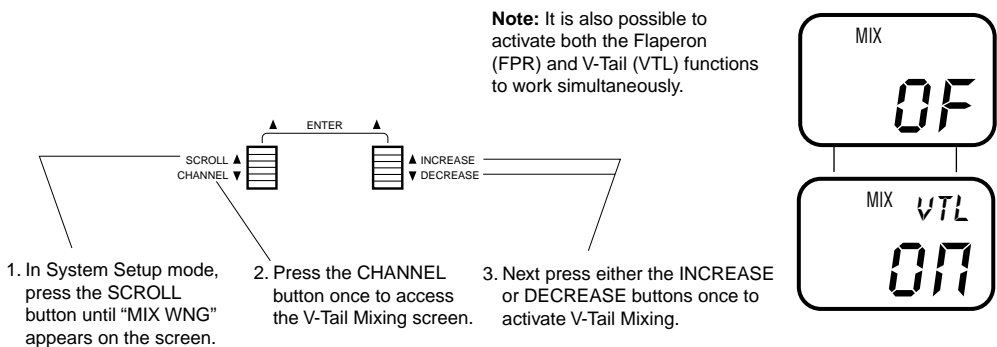

6.5

MODEL SELECTION

The XP662 has memory for six models. It can store the settings for six airplanes, six helicopters, or three airplanes and three helicopters, etc.

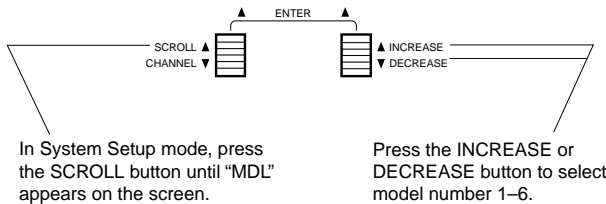
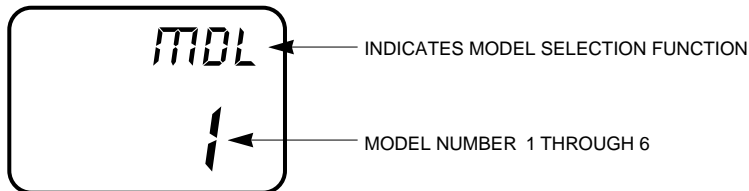

Accessing the Model Selection Function

1. Press the SCROLL and INCREASE buttons simultaneously and hold.
2. Turn on the transmitter to enter the system mode.
3. Press the SCROLL button until "MDL" appears on the screen.
4. Press the INCREASE or DECREASE button to select model number 1 through 6.
5. Press the SCROLL button to access the Model Name entry function.
6. To exit, press the SCROLL and INCREASE buttons simultaneously.



6.6

MODEL NAME ENTRY

The XP662 allows a three-digit name to be input for each of the six models available. The current model

will be displayed in the normal display. This feature helps identify different aircraft types or model setups.

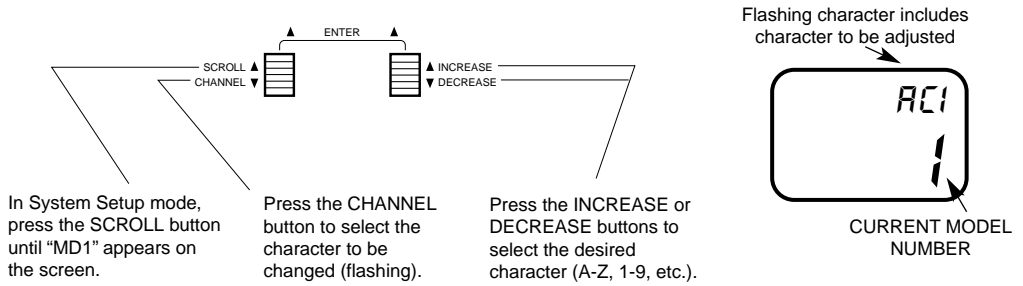

Accessing the Model Name Entry Function

1. Press the SCROLL and INCREASE buttons simultaneously and hold.
2. Turn on the transmitter to enter the System mode.
3. Press the SCROLL button until "AC1" appears on the screen.
4. Press the INCREASE or DECREASE buttons to select the correct letter/number for the first character (flashing).
5. To adjust the remaining two characters, press the CHANNEL button until the desired character to be adjusted is flashing.
6. Press the SCROLL button to access the Modulation Select function.
7. To exit, press the SCROLL and INCREASE buttons simultaneously.



6.7 MODULATION SELECT

The modulation select function enables your XP662 to transmit to a variety of JR receivers that are already, or may soon be, in existence. You can select from either PPM (FM), Z-PCM or S-PCM, depending on the central processing unit within your receiver to utilize existing receivers, or to upgrade your XP662 flight pack for future models. Your system comes factory preset in the FM or PPM (Pulse Position Modulation) position so that it is compatible with the included R700 FM receiver.

Please refer to the receiver compatibility chart below when selecting the modulation type for various JR receivers.

Note: Once the proper modulation has been selected for a specific model number, the modulation type will remain the same for that model number, even during model number/type changes. In other words, if you have one model on FM/PPM and one model on PCM, the system will automatically change modulation types once the correct modulation has been selected for that model.

| TX Modulation | Compatible Receivers | # of Channels & Brief Description | TX Modulation | Compatible Receivers | # of Channels & Brief Description |
|---------------|----------------------|-----------------------------------|---------------|-----------------------------|-----------------------------------|
| PPM (FM) | NER-226 | 6 (micro) | Z-PCM | NER-236 | 6 (micro) |
| PPM (FM) | NER-228 | 8 | Z-PCM | NER-627XZ or 627 "G" series | 7 |
| PPM (FM) | NER-327x | 7 | Z-PCM | NER-J329P | 9 |
| PPM (FM) | NER-527x | 7 (micro) | Z-PCM | NER-910XZ | 10 |
| PPM (FM) | NER-529x | 9 (micro) | S-PCM | NER-D940S | 10 |
| PPM (FM) | NER-549 | 9 | S-PCM | NER-649S | 9 |
| PPM (FM) | NER-600 | 6 (micro) | S-PCM | NER-950S | 10 |
| PPM (FM) | NER-700 | 7 (Slimline) | | | |

Accessing the Modulation Select Function

1. Press the SCROLL and INCREASE buttons simultaneously and hold.
2. Turn on the transmitter to enter the System mode.
3. Press the SCROLL button until "PPM" appears on the screen.
4. Press either the INCREASE or DECREASE buttons to change the modulation to the desired setting FM (PPM), Z-PCM (ZPC) or S-PCM (SPC).
5. Press the SCROLL button to access the Model Type function.
6. To exit, press the SCROLL and INCREASE buttons simultaneously.

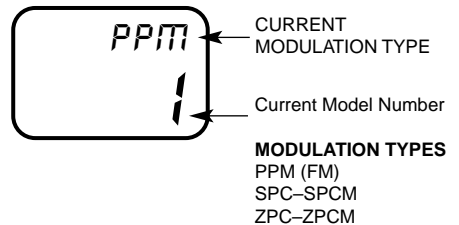
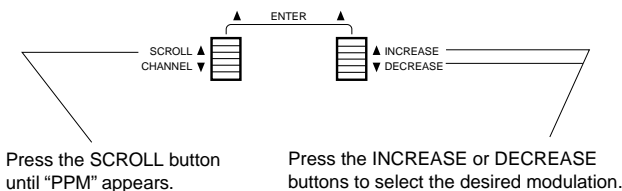

* **Note:** The modulation for the current model in use can be viewed at a glance by pressing the SCROLL button with the system in the normal screen position.

* **Note:** If either S-PCM or Z-PCM modulation is selected, pressing the MODE button will access the Fail-Safe/Hold function.



6.8 FAIL-SAFE/HOLD

The Fail-Safe/Hold function is available only when you use the XP662 transmitter in either of the PCM modulations: S-PCM or Z-PCM. This function is designed to help minimize damage to your airplane during a loss of signal to the receiver. The servos either assume the fail-safe presets or hold the last good signal position.

Note: In the PCM modulations, the Fail-Safe/Hold function cannot be totally disabled so that the servos will react to interference in the same way as they do in a PPM system. This is only possible with the use of a PPM receiver and the transmitter in the PPM modulation.

Note: Since the actual screen appearance varies, depending on the modulation of your radio, refer to the appropriate modulation section which follows (Z-PCM, S-PCM).

As noted earlier, if you are in the PPM modulation, the Fail-Safe/Hold function is not applicable. Therefore, the Fail-Safe/Hold function will not appear on your LCD in the PPM mode.

Refer to the Modulation Selection section for more information pertaining to the broadcast signal of your XP662 transmitter.

6.9 FAIL-SAFE/HOLD FUNCTION IN Z-PCM MODULATION

Hold (Z-PCM)

The Hold function is automatically activated when the radio is turned on and is in the Z-PCM modulation.

This function stops (or holds) the servos in the positions they were in just prior to the interference. Therefore, your airplane maintains the position held immediately before the interference was experienced.

When a clear signal is restored, the Hold function releases, and control of the airplane returns to you.

If you would prefer your control surfaces to move to a chosen position during a loss of signal, please refer to the time delay/memory section below.

Accessing Fail-Safe/Hold (Z-PCM)

When the Fail-Safe function is activated (i.e., when the signal is interrupted), the transmitter automatically moves each servo to a preset position. The position that each servo assumes is determined by you, as is the time length of interference that must occur before servo movement.

After the interference has ceased, control of the airplane returns immediately to you.

There are three time delays to choose from: 1/3 (0.3) second, 1/2 (0.5) second and 1.0 second. These time delays are the amount of time it takes, starting the

moment the interference occurs, until the servos assume their preset positions.

1. Press the SCROLL and INCREASE button simultaneously and hold.
2. Turn on the transmitter to enter the System mode.
3. Press the SCROLL button until "FST" appears on the screen.

Note: If Fail-Safe does not appear on your LCD, it is because you are transmitting in PPM. Fail-Safe is not applicable in the PPM mode. Refer to the Modulation Mode Selection section for more information.



6.9

FAIL-SAFE/HOLD FUNCTION IN Z-PCM MODULATION (continued)

Setting Fail-Safe/Hold Time Delay/Memory In Z-PCM Modulation

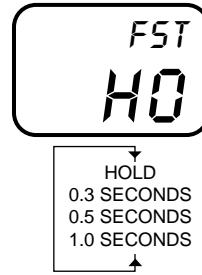
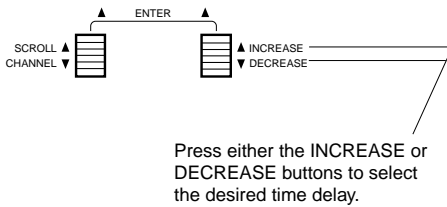

HO = ALL SERVOS HOLD
 0.3 = 1/3 SECOND TIME DELAY
 0.5 = 1/2 SECOND TIME DELAY
 1.0 = 1 SECOND TIME DELAY

1. After accessing the Fail-Safe function, it is now time to adjust the fail-safe time presets.
2. Select among the three time delays (0.3, 0.5, or 1.0 seconds) by pressing either the (+) or (-) buttons until the desired setting appears on the screen.

Setting Servo Position Presets

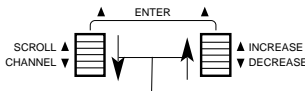

Press the CHANNEL and INCREASE buttons simultaneously to store the fail-safe servo presets.



CL WILL FLASH WHEN FAIL-SAFE SERVO POSITIONS ARE ENTERED.

Note: If the Hold position (HO) is selected, this function/screen will not be present.

1. Press the SCROLL button until "FSM" appears on the screen.
2. Set all controls to the desired fail-safe position, then press the CHANNEL and INCREASE buttons simultaneously. A high-pitch beep sound will confirm that the preset positions have been entered.
3. Hold the transmitter sticks in the position that you want the servos to assume during signal loss conditions. You can determine fail-safe preset positions for the other channels by placing the control knobs and switches in the positions that you want them to assume during interference.
4. With the sticks, switches and control knobs in the fail-safe positions, press the CHANNEL and INCREASE buttons simultaneously. This will enter these locations as the fail-safe memory settings. A high-pitched beep will indicate that this setting has been stored.
5. To confirm that the input of data was successful, switch the transmitter off. The controls will move to the input locations. If not, repeat Step 4 again.
6. To exit the Fail-Safe function, press the SCROLL and INCREASE buttons simultaneously.

Note: These preset positions remain stored in the transmitter's memory until both the transmitter battery pack and the lithium back-up battery have been removed (or until data reset has been performed). Therefore, you do not have to reset the fail-safe each time you fly. Should you want to re-adjust the fail-safe presets, access the Fail-Safe function and adjust the presets as you have just done. The transmitter automatically recalls the settings for the last fail-safe adjustment.



6.10

FAIL-SAFE/HOLD FUNCTION IN S-PCM MODULATION

Hold Function (S-PCM)

The Hold function is automatically activated when the radio is turned on and in the S-PCM modulation.

This function stops (or holds) the servos in the positions they were in just prior to the interference.

Therefore, your aircraft maintains the position held immediately before the interference was experienced. When a clear signal is restored, the Hold function releases, and control of the airplane returns to you.

Fail Safe/Hold Combination in S-PCM Modulation

The XP662 allows you to combine the hold and fail-safe presets for all six channels on the receiver. You can select fail-safe or hold independently for all channels on your aircraft. In other words, some channels will hold their last clear signal position, while others assume the preset position. Once the fail-safe has been activated by signal interruption (interference), the transmitter automatically moves

the servos to a preset position. The predetermined servo positions are set by you. In the S-PCM fail-safe, the time delay (the amount of time it takes, starting the moment the interference occurs, until the servos assume the preset positions) is fixed at .3, or 1/3, second.

After the interference has ceased, normal operation of the airplane returns to you immediately.



6.10

FAIL-SAFE/HOLD FUNCTION IN S-PCM MODULATION (continued)

Activating Servo Fail-Safe Presets by Channel (S-PCM)

1. Press the SCROLL and INCREASE buttons simultaneously and hold.
2. Turn on the transmitter to enter the system mode.
3. Press the SCROLL button until "FS1" appears on the screen. The #1 on the screen refers to the specific channel (1-6) to be adjusted.
4. Press the (+) or (-) button to activate (turn on) the preset position function for that channel.
5. Press the CHANNEL button to move to the next channel(s) to be adjusted (2-6). Repeat Step 4 for each channel to be activated.

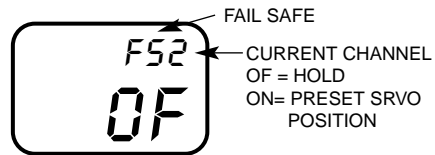
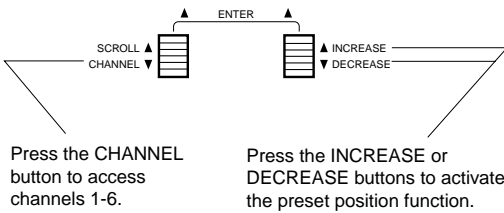

Note: If the Hold position (HO) is selected for all six channels, this function/screen will not be present.

Setting Servo Fail-Safe Presets in S-PCM Modulation

1. Press the MSCROLL button until "FSM" appears on the screen.
 2. Set all controls to the desired fail-safe positions.
- Next press the CHANNEL and INCREASE button simultaneously. A-high pitch beep sound will confirm that the preset positions have been entered and accepted.

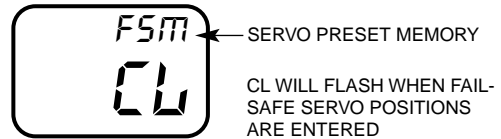
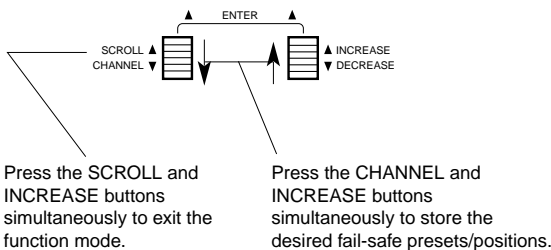

7.1 SERVO REVERSING

Servo reversing is a very convenient function used in the setup of a new aircraft. It is used to change the direction of servo rotation in relation to the

corresponding stick movement. Servo reversing is available for all six channels.

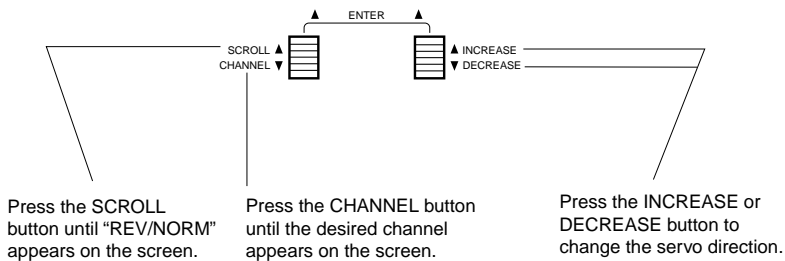
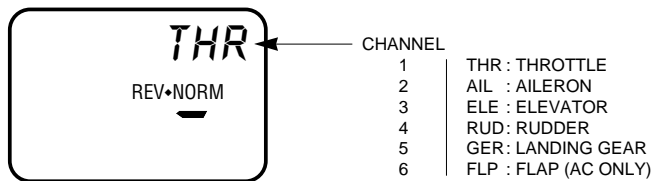

Accessing the Servo Reversing Function

1. Turn on the transmitter.
2. Press the SCROLL and INCREASE buttons simultaneously to enter the function mode.
3. Press the SCROLL button until "REV-NORM" appears on the screen.
4. Press the CHANNEL button until the desired channel appears on the screen.
5. Press the INCREASE or DECREASE button to change the servo direction.
6. Press the SCROLL button to access the Dual Rate function.
7. To exit, press the SCROLL and CHANNEL buttons simultaneously.



7.2

DUAL RATE

Dual rate is available for the aileron and elevator channels. The purpose of this function is to allow for in-flight selection of two preset servo travels for each of these channels. The amount of travel is adjustable from 0-125%. The factory settings for both switch positions (0 and 1) is 100%. Either position may be selected as the low or high rate by placing the switches in the desired position and adjusting the value for that position. Operation of these switches is described in Section 6.3.

Different types of maneuvers require varying amounts of control movements. Snap rolls require large control movements, while smooth maneuvers like long slow rolls are best performed with smaller control movements. Dual rates allow you to change the control movements in flight at the flip of a switch. This allows you to execute maneuvers requiring both radical control movements and small control movements during a single flight.

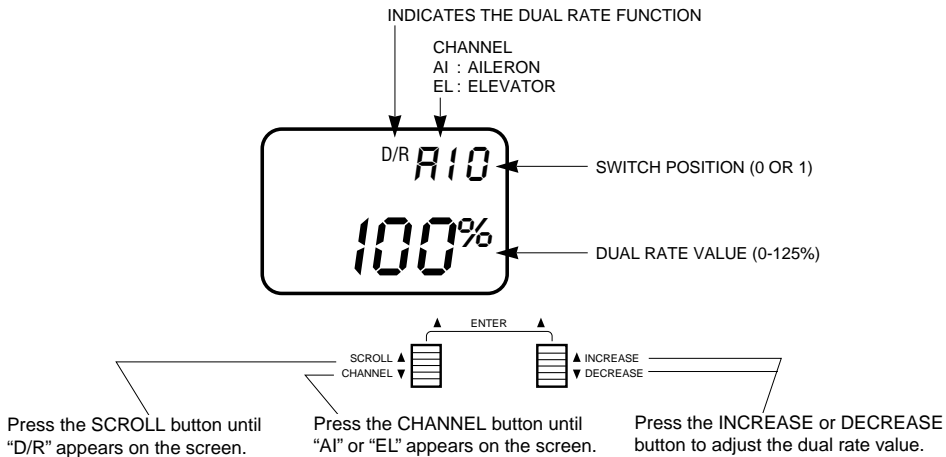

Accessing the Dual Rate Function

1. Turn on the transmitter.
2. Press the SCROLL and INCREASE buttons simultaneously to enter the function mode.
3. Press the SCROLL button until "D/R" appears on the screen.
4. Press the CHANNEL button until the desired channel appears on the screen (AI = aileron or EL = elevator).
5. The number that appears directly to the right of the selected channel is the switch position. There are two switch positions, 0 and 1, for each of the channels. An "0" will appear when the selected dual rate switch is in the uppermost position and a "1" when the selected switch is in the lower position.
6. To change the switch selection you must enter the dual rate switch selection function in the system mode (see Section 6.3).
7. The number in the center of the screen indicates the current dual rate value for the selected switch position and channel. Press the INCREASE or DECREASE button to adjust the dual rate value (0-125%).
8. After adjusting the value for the 0-switch position, change to the 1-switch position and adjust the rates.
9. Press the CHANNEL button to select the other channel and adjust the dual rate value for both switch positions.
10. Press the SCROLL button to access the Exponential Rate feature.
11. To exit, press the SCROLL and INCREASE buttons simultaneously.



7.3

EXPONENTIAL

Programmable exponential adjustments are offered on the aileron and elevator channels of your XP662 system. Exponential is a function that allows you to tailor the response rate of the controls as compared to the stick inputs. The purpose of exponential is to reduce the sensitivity in the middle portion of stick movement, while still allowing full travel at the end of the stick movement. In other words, the end result (travel) remains the same, although exponential changes the rate at which it achieves this travel.

The adjustable range of the Exponential function is from 0–100%. Zero percent (0%) is linear stick control which means that the response rate is equal

throughout the stick control. One hundred percent (100%) is full exponential. The larger the exponential value, the less servo action, or sensitivity, you will notice around the neutral setting.

Note: The Exponential function operates in conjunction with the Dual Rate function. It is imperative to understand the Dual Rate function prior to adjusting the exponential values.

Exponential may be selected independently for either the high or low rate (position 0 or 1) or both.

Note: The dual rate switch position is changed/accessed by setting the appropriate dual rate switch to the 0 or 1 positions.

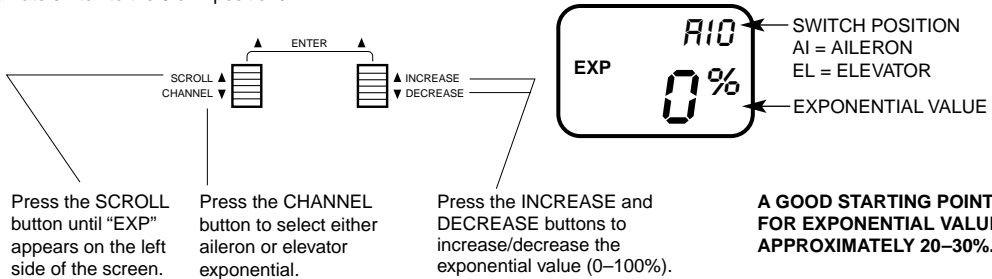

Accessing the Exponential Function

1. Turn on the transmitter.
2. Press the SCROLL and INCREASE buttons simultaneously to enter the Function mode.
3. Press the SCROLL button until "EXP" appears at the left side of the screen.
4. Press the CHANNEL button until the desired channel appears on the screen (AI or EL).
5. Using the appropriate dual rate switch, select the correct position to be adjusted (0 or 1).
6. Press the (+) or (-) buttons to increase/decrease the exponential value.
7. Press the SCROLL button to access the Sub-Trim function.
8. To exit, press the SCROLL and INCREASE buttons simultaneously.



7.4 SUB-TRIM

Sub-trim is an electronic trim that is available for each of the six channels. Sub-trim is particularly useful as it allows the mechanical trim levers to be returned to their neutral positions by adjusting/ changing the servo's neutral position electronically, without the need to mechanically adjust the specific control linkage. This allows the same mechanical trim lever settings between the four models you can

control with this radio system. Sub-trim can also allow additional trim travel when mechanical trims do not provide enough movement.

Note: It is recommended to use as little subtrim as possible for adjustment. If more than 20–30 points are required, it is suggested that a mechanical linkage adjustment be performed.

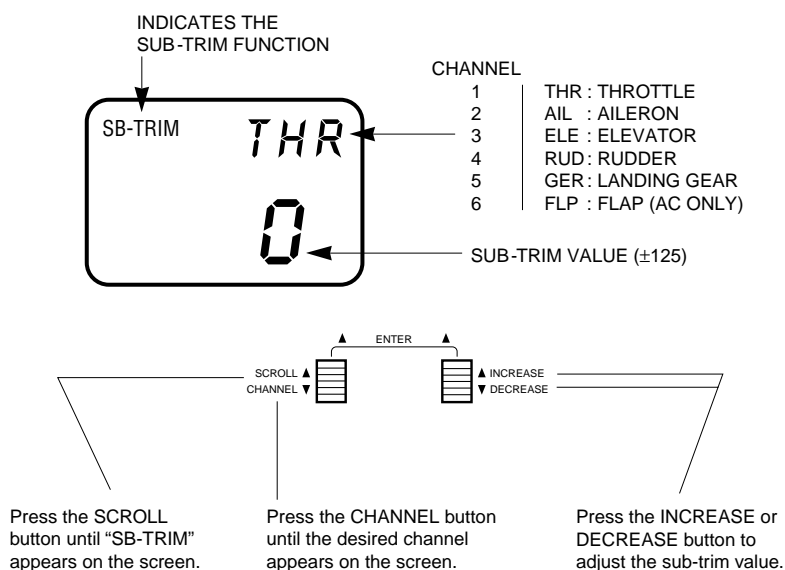

Accessing the Sub-Trim Function

1. Turn on the transmitter.
2. Press the SCROLL and INCREASE buttons simultaneously to enter the function mode.
3. Press the SCROLL button until "SB-Trim" appears on the screen.
4. Press the CHANNEL button until the desired channel appears on the screen.
5. Press the INCREASE or DECREASE button to establish the desired amount of sub-trim.
6. Press the SCROLL button to access the travel adjustment function.
7. To exit, press the SCROLL and INCREASE buttons simultaneously.



7.5 TRAVEL ADJUSTMENT

The amount of servo travel is adjustable for each direction for each of the six channels individually. The adjustment range is from 0% to 150%. Travel adjustment is factory set at 100% for all channels. The travel adjustment value displayed on the screen

depends on the position of the stick or switch (e.g., flap switch, gear switch). This function is useful either to maximize control surface travel, or to reduce travel to eliminate servo binding without the need for mechanical adjustment.

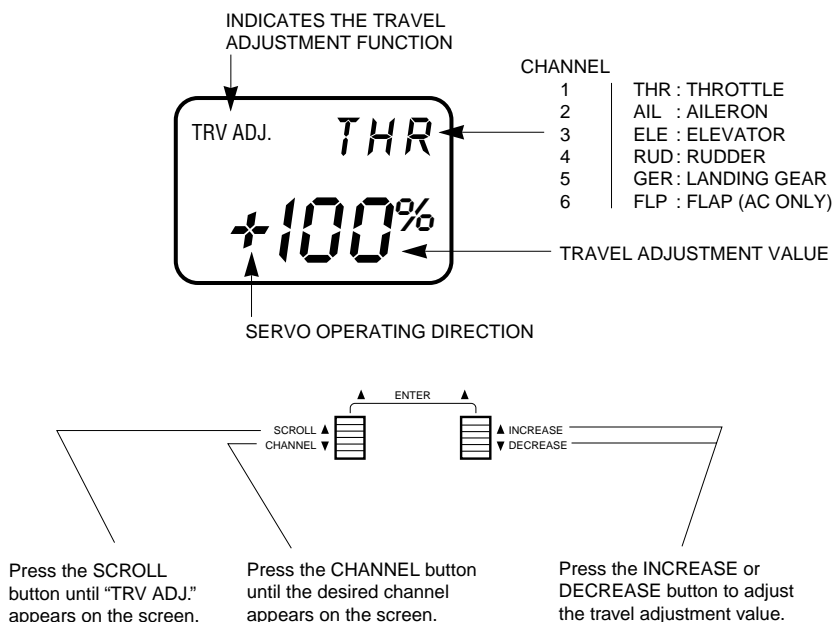

Accessing the Travel Adjustment Function

1. Turn on the transmitter.
2. Press the SCROLL and INCREASE buttons simultaneously to enter the function mode.
3. Press the SCROLL button until "TRV ADJ." appears on the screen.
4. Press the CHANNEL button until the desired channel appears on the screen.
5. Move the selected channel stick or switch in the direction that you want to adjust the travel. Press the INCREASE or DECREASE button to achieve the desired travel. Move the stick in the opposite direction to adjust the travel in the opposite direction.
6. The same may be done for all channels.
7. Press the SCROLL button to access the aileron-to-rudder mixing function.
8. To exit, press the SCROLL and INCREASE buttons simultaneously.



7.6

AILERON-TO-RUDDER MIXING

On some types of aircraft, it is desirable to mix aileron and rudder to make coordinated turns. The XP662 allows the mixing of aileron-to-rudder and allows you to adjust the amount and direction of

mixing. The aileron-to-rudder mixing can be left on all the time, or it can be turned off with the selection of one of three switches.

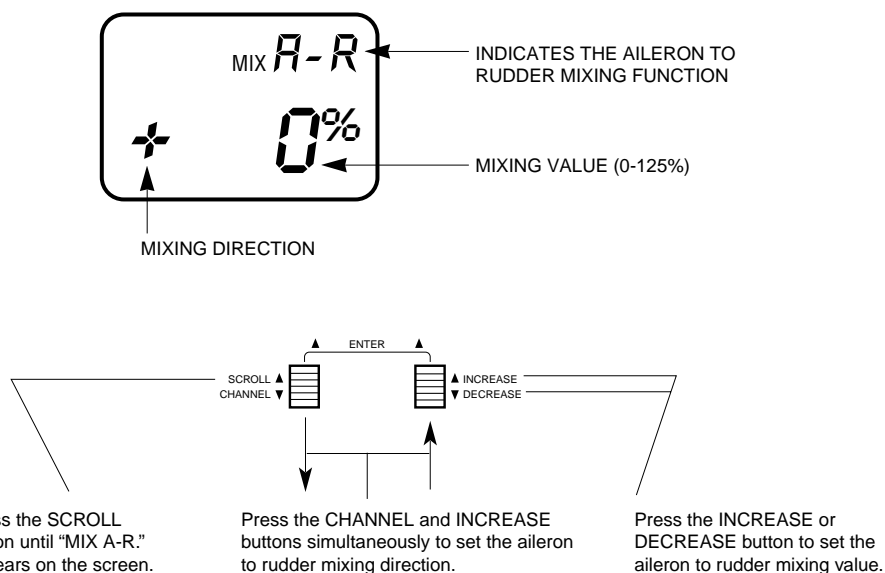

Accessing the Aileron-to-Rudder Mixing Function

1. Turn on the transmitter.
2. Press the SCROLL and INCREASE buttons simultaneously to enter the Function mode.
3. Press the SCROLL button until "MIX A-R" appears on the screen.
4. Press the CHANNEL and INCREASE button to set the desired amount and direction of aileron-to-rudder mixing.

Note: If "OF" appears on the screen, it is because the aileron to rudder mixing switch is in the off position.



7.6 AILERON-TO-RUDDER MIXING (continued)

Aileron-to-Rudder Mixing Switch Selection

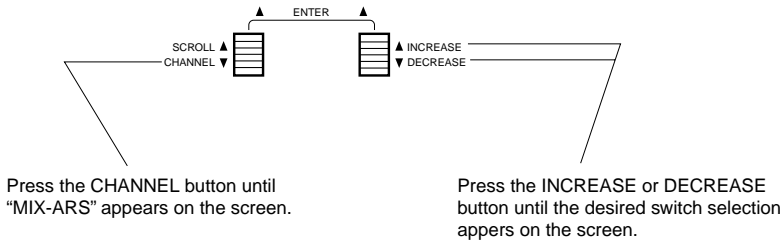
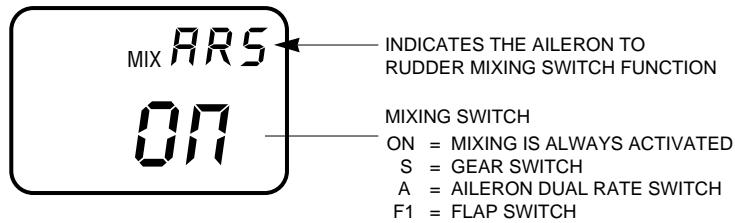

Accessing the Aileron-to-Rudder Mixing Switch Function

1. Follow Steps 1 through 4 as on the previous page.
2. Press the CHANNEL button until "MIX ARS" appears on the screen.
3. Press the INCREASE or DECREASE button until the desired switch selection appears on the screen.
4. Press the SCROLL button to access the elevator-to-flap mixing function.
5. To exit, press the SCROLL and INCREASE buttons simultaneously.



7.7

ELEVATOR-TO-FLAP MIXING

Elevator-to-flap mixing is commonly used to quicken the pitching rate of an aircraft. This is very popular in fun fly airplanes because it allows tighter loops.

Normally, with up elevator the flaps go down, while down elevator makes the flaps go up.

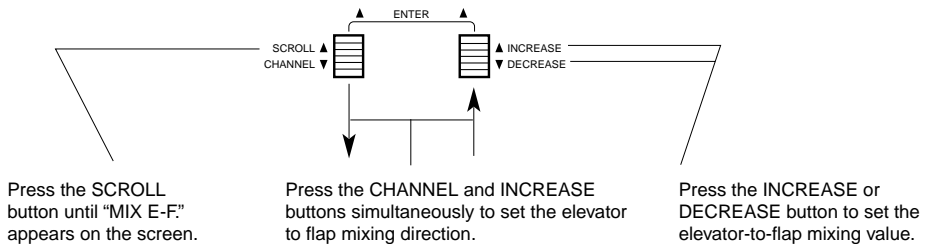
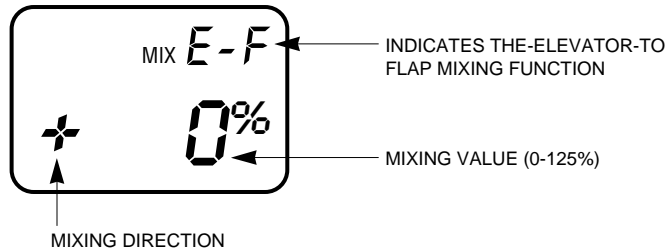

Accessing the Elevator-to-Flap Mixing Function

1. Turn on the transmitter.
2. Press the SCROLL and INCREASE buttons simultaneously to enter the function mode.
3. Press the SCROLL button until "MIX E-F" appears on the screen.
4. Press the CHANNEL and INCREASE buttons simultaneously to set the elevator-to-flap mixing direction.
5. Press the INCREASE or DECREASE button to set the elevator-to-flap mixing value.



7.7 ELEVATOR-TO-FLAP MIXING (continued)

Elevator-to-Flap Mixing Switch Selection

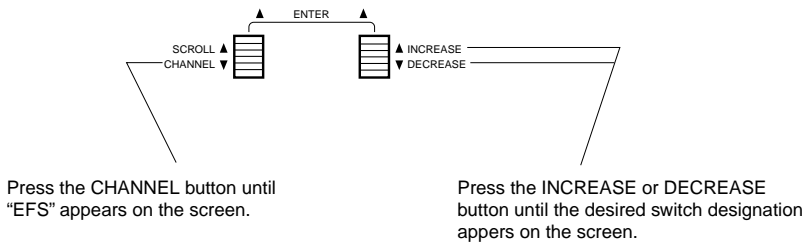
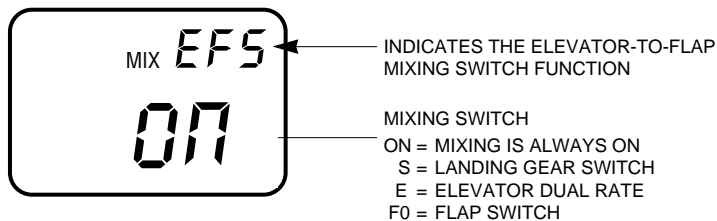

Accessing the Elevator-to-Flap Mixing Switch Function

1. Follows Steps 1 through 4 as on the previous page.
2. Press the CHANNEL button until "MIX EFS" appears on the screen.
3. Press the INCREASE or DECREASE button until the desired switch designation appears on the screen.
4. Press the SCROLL button to access the differential function if flaperons or delta-wing types are activated in the system mode. If flaperons are not activated, pressing the SCROLL button will access the flap-to-elevator offset function.
5. To exit, press the SCROLL and INCREASE buttons simultaneously.



7.8

DIFFERENTIAL

Aileron differential is used to correct roll to yaw coupling and adverse yaw characteristics. In order to activate differential, the flaperon wing type must have been selected in the system mode (see Section 6.4). Also, each aileron control surface must have its own

servo with the right aileron servo plugged into the aileron channel (#2) on the receiver and the left aileron servo plugged into the Flap Aux 1 channel (#6) on the receiver.

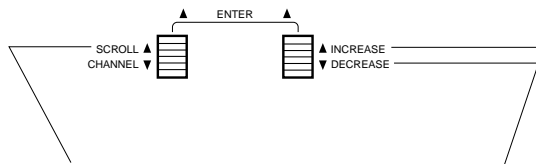
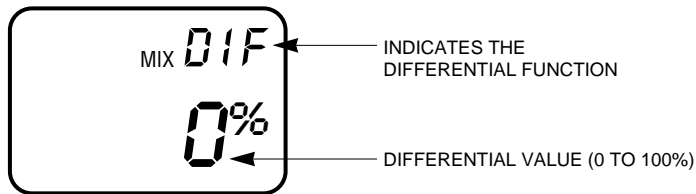

Press the SCROLL button until "MIX DIF" appears on the screen.

Press the INCREASE or DECREASE button to adjust the differential value.

Accessing the Differential Function • Flaperon/Delta Mode Only

1. Turn on the transmitter.
2. Flaperon wing type must be selected (see Section 6.4).
3. Press the SCROLL and INCREASE buttons simultaneously to enter the function mode.
4. Press the SCROLL button until "MIX DIF" appears on the screen.
5. Press the INCREASE or DECREASE button to adjust the differential mixing value.
6. Press the SCROLL button to access the flap-to-elevator offset trim function.
7. To exit, press the SCROLL and INCREASE buttons simultaneously.



7.9 FLAP-TO-ELEVATOR OFFSET TRIM

When the flaps are deployed, most airplanes exhibit pitching tendencies (most pitch nose up). Elevator offset trim is designed to prevent this pitching. Flap to elevator offset trim automatically retrim the elevator to a preset value when the flap switch is activated.

Note: Flap-to-elevator offset trim is also useful as a dual elevator trim even for airplanes without flaps. This is especially helpful for sailplanes that require one trim setting for launch and another trim setting for flight.

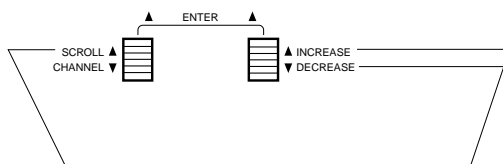
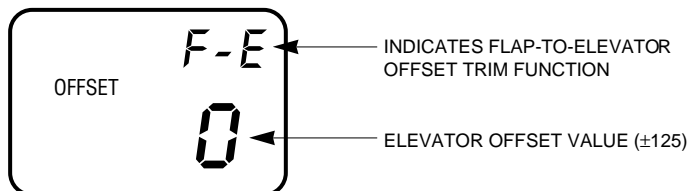

Press the SCROLL button until "OFFSET F-E" appears on the screen.

Press the INCREASE or DECREASE button to adjust the flap-elevator offset value.

Accessing the Flap-to-Elevator Offset Trim Function

1. Turn on the transmitter.
2. Press the SCROLL and INCREASE buttons simultaneously to enter the function mode.
3. Press the SCROLL button until "OFFSET F-E" appears on the screen.
4. Press the INCREASE or DECREASE button to set the desired amount and direction of the elevator offset.

- Note:** It is helpful to have the flap switch on when making this adjustment.
5. Press the SCROLL button to access the Programmable Mix function.
 6. To exit, press the SCROLL and INCREASE buttons simultaneously.



7.10 PROGRAMMABLE MIXING (A,B,C)

The XP662 in aircraft mode offers three programmable mixes to be used for a number of different purposes. The functions allow mixing any one channel to any other channel.

The mix can remain ON at all times, or be switched OFF in flight using a number of different switches. (Refer to Chart A). Each channel is identified by channel numbers 1-6 (i.e., 2 = aileron, 4 = rudder, etc.—See Chart B) The channel appearing first is known as the “master channel,” or the channel to which you want to mix. The second channel is known

as the “slave channel” or the channel that is being mixed into the master channel. For example, “AILE-RUDD” would indicate aileron-to-rudder mixing. Each time the aileron stick is moved, the aileron will deflect, and the rudder will automatically move in the direction and to the value input. Mixing is proportional, so small inputs of the master channel will produce small outputs of the slave channel. Each programmable mix has a mixing “offset.” The purpose of the mixing offset is to redefine the neutral position of the slave channel.

Chart A Switch Selection
MIX

| SWITCH | A | B | C |
|-------------------------------|----|----|----|
| Always ON | ON | ON | ON |
| Flap/Mix Switch Position 1 ON | F1 | F1 | F1 |
| Aileron DIR Switch | A | A | / |
| Elevator DIR Switch | E | E | / |
| Flap/Mix Switch Position 0 ON | / | / | F0 |
| Gear/Mix Switch | / | / | 5 |

Chart B Channel Numbers

| CHANNEL NUMBER | FUNCTION |
|----------------|----------|
| 1 | Throttle |
| 2 | Aileron |
| 3 | Elevator |
| 4 | Rudder |
| 5 | Gear |
| 6 | Flap |

Accessing the Programmable Mixing Function

1. Turn on the transmitter
2. Press the SCROLL and INCREASE buttons simultaneously to enter the Function mode.
3. Press the SCROLL button until “MIX A11” appears at the top right corner of the screen. This is Program Mix A. Pressing the SCROLL button again will select mixes B and C.



Press the SCROLL button until “MIX A11” appears.

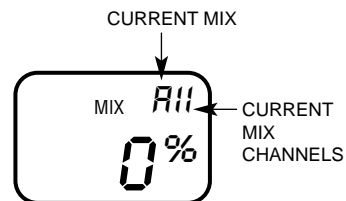

7.10 PROGRAMMABLE MIXING (A,B,C) (continued)

Assigning Channels

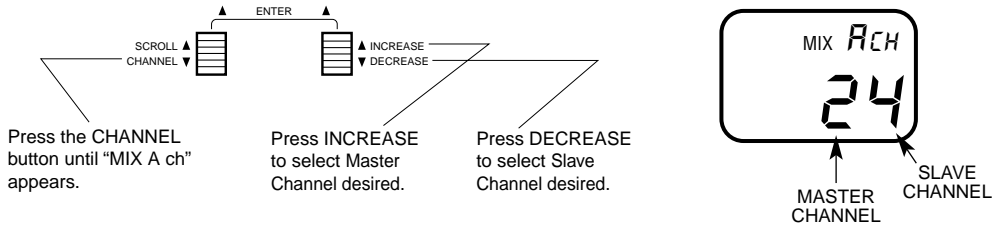

1. Press the channel button twice until "MIX A CH" appears on the screen.
2. Press the (+) button to select the desired Master Channel (1-6).
3. Press the (-) button to select the desired Slave Channel (1-6). Refer to Chart B on the preceding page for channel number clarification.

Switch Selection

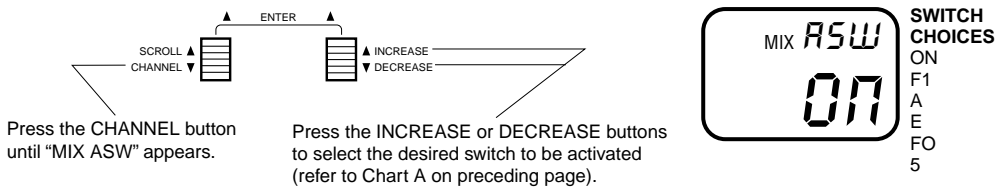

1. Press the CHANNEL button once until "MIX ASW" appears.
2. Press the INCREASE or DECREASE button to select the switch to be used to activate the mixing or leave on if a constant mix is desired. (Refer to Chart A on the preceding page for possible mix/switch selections.)



7.10 PROGRAMMABLE MIXING (A,B,C) (continued)

Mixing Value Adjustment

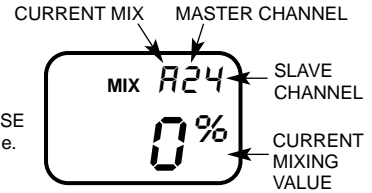
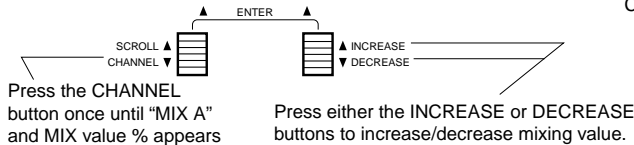

1. Press the CHANNEL button once until "MIX A" appears, with the mixing value located at the bottom of the screen.
2. To set the Slave Channel's mixing value, move and hold the Master Channel control stick to the direction to be adjusted (up/down—left/right), then press the INCREASE key to add positive mixing value, or the DECREASE key to add negative mixing value (+/-125%). When the

master channels stick is moved, the display will automatically show the mixing value for the current stick direction.

Note: If a mix switch position other than on is selected, it will be necessary to move the selected switch to the on (or active) position to adjust the mixing value. "OF" will appear on the screen if the selected mixing switch is in the off position.

Mixing Offset Adjustment

The purpose of the mixing offset feature is to redefine the neutral position of the slave channel to be mixed. Any desired position may be selected for the offset reference point. To set the offset position, place the master channel's stick to the desired position and press either the INCREASE or

DECREASE keys. This position is now stored in the memory and its offset value from the neutral position of the master channel is indicated numerically on the LCD display. Then, the mixing value at the determined offset position is now set at 0.

Accessing the Offset Function

1. Press the CHANNEL button once until offset appears in the center of the screen.
2. Place the master channel stick to the desired position of slave channel offset, then press either the INCREASE or DECREASE button to store.
3. Press the SCROLL button once to access Program Mix B, press twice to access program MIX C, and a third time for servo reversing.
4. To exit the Function mode, press the SCROLL and INCREASE buttons simultaneously.

Note: If a mix switch position other than on has been selected, it will be necessary to move the selected switch to the on or active position to set the offset value. "OF" will appear on the screen if the selected mixing switch is in the off position.

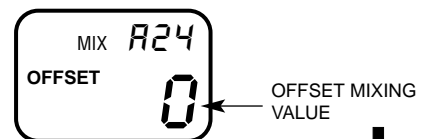
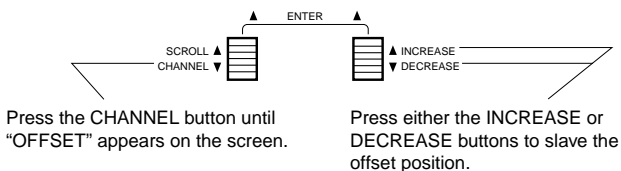

8

Data Sheet

Modulation SPCM • ZPCM • PPM (FM)

Model Number _____

Model Name _____

| CHANNELS | THRO (1) | AIL (2) | ELE (3) | RUDD (4) | GER(5) | AUX1 (6) |
|---------------|------------------|------------------|------------------|------------------|------------------|------------------|
| REVERSE SW | NORM • REV | NORM • REV | NORM • REV | NORM • REV | NORM • REV | NORM • rev |
| SUB-TRIM | | | | | | |
| TRAVEL ADJUST | + % | + % | + % | + % | + % | + % |
| (TRV ADJ.) | - % | - % | - % | - % | - % | - % |
| % | | | | | | |

FAIL-SAFE TIME (ZPCM) _____

D/R SW EA • A • E • CF

LANDING ELEV OFFSET ±

| | |
|--------------|-------------------------------------|
| WING TYPE | NORM • FLAPERON • DELTA |
| V-TAIL | ON • OFF |
| DIFFERENTIAL | _____ % |

| | | AIL (AI) | ELEV (EL) |
|-----------------------|-------|----------|-----------|
| DUAL RATE • EXP | POS 0 | D/R | _____ % |
| | | EXP | _____ % |
| | POS 1 | D/R | _____ % |
| | | EXP | _____ % |

| | MIX SW | POS |
|---------------------|-----------------|---------|
| AIL ELEV → RUDD MIX | ON • 5 • A • F1 | _____ % |
| ELEV → FLAP MIX | ON • 5 • E • F0 | _____ % |

| | | CHANNEL MASTER SLAVE | MIX SWITCH | OFFSET | +GAIN | -GAIN |
|-----------|---|----------------------------|------------------|--------|-------|-------|
| PROG. MIX | A | → | ON • F1 • A • E | | | |
| | B | → | ON • F1 • A • E | | | |
| | C | → | ON • F1 • F0 • 5 | | | |



1.1 CONTROL IDENTIFICATION AND LOCATION • Mode II

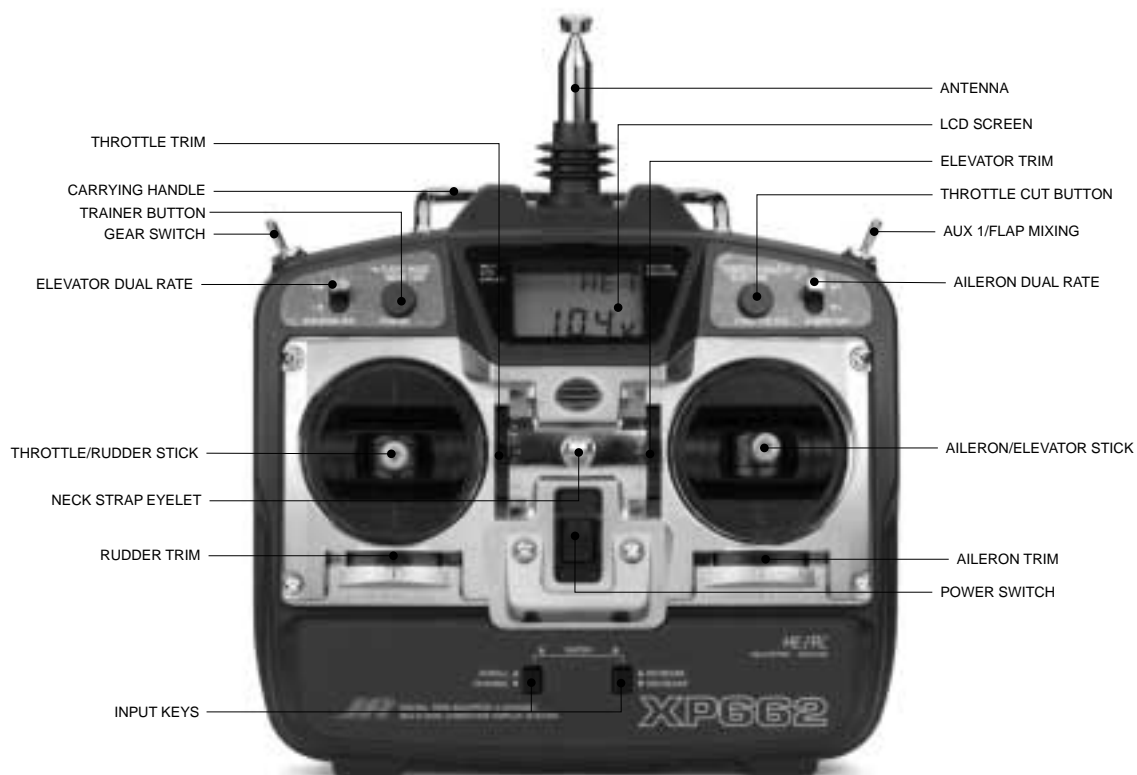

1.2 RECEIVER CHANNEL ASSIGNMENT/TRANSMITTER THROTTLE ALT

- | | | |
|----|-------|-----------------------------|
| 1. | THRO | Throttle Channel |
| 2. | AILE | Aileron Channel |
| 3. | ELEV | Elevator Channel |
| 4. | RUDD | Rudder Channel |
| 5. | GEAR | Gear Channel |
| 6. | AUX 1 | Auxiliary 1 Channel (Pitch) |

Transmitter Throttle ALT

The Throttle ALT function makes the throttle stick trim active only when the throttle stick is less than half throttle. This gives easy, accurate idle adjustments without affecting the high throttle position.



1.3 TRANSMITTER REAR

Note: Your transmitter has a 5-year lithium battery to protect your pre-programmed data against main transmitter battery failure. If your system reads 0.0 volts, or has an unfamiliar display (service mode)

or your data resets to the factory defaults, return your transmitter to Horizon Service Center (see page 85) for lithium battery replacement.



Transmitter Crystal Replacement Notice
The Federal Communications Commission (FCC) requires that changes in transmitter frequency must be performed only by an authorized service technician (Horizon Service Center). Any transmitter frequency change made by non-certified technician may result in a violation of the FCC rules.



1.4 CONTROL STICK LENGTH ADJUSTMENT

To adjust the control stick length, use a 2mm Allen wrench to unlock the set screw located inside the end of the control stick. Turn the set screw counterclockwise to loosen it, then turn the knurled portion of the stick to adjust the length. Counterclockwise will lengthen the stick and clockwise will shorten it. After the control stick(s) has been adjusted to suit your flying style, tighten the set screw back.

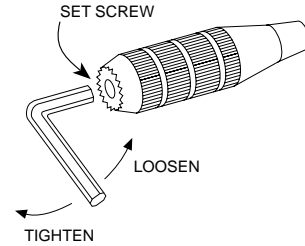

1.5 DIRECT SERVO CONTROL (DSC)

For proper DSC hook-up and operation:

1. Leave the transmitter power switch off. The transmitter will not transmit any radio frequency (RF) in this position.
2. Plug the optional DSC Cord (JRPA132) into the DSC port in the rear of the transmitter.
3. The encoder section of the transmitter will now be operational and the LCD display will be lit.
4. Plug the other end of the DSC Cord into the receiver charge receptacle. Turn on the switch harness.

Note: When installing the optional Charging Jack (JRPA025), be sure to hook the charging jack receptacle securely into the switch harness charge cord.

Why you should use the DSC function:

1. The DSC enables you to check the control surfaces of your aircraft without drawing the fully operational 200mAh from your transmitter battery pack. Instead, you will only draw 70mAh when using the DSC function.

Note: You will need to purchase (separately) both the DSC Cord (JRPA132) and the JR Deluxe Switch Harness (JRPA001) to make use of the XP662 DSC Function.

2. The DSC function allows you to make final adjustments to your airplane or helicopter without transmitting any radio signals. Therefore, if another pilot is flying on your frequency, you can still adjust your aircraft and not interfere with the other aircraft.

Note: Under no circumstances should you attempt to fly your aircraft with the DSC Cord plugged in! This feature is for bench checking your aircraft only.

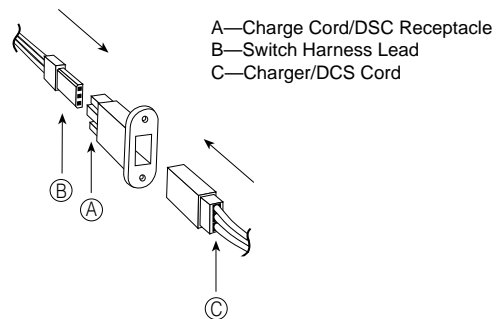

1.6 NECK STRAP ATTACHMENT

There is an eye hook on the front of the transmitter for attaching an optional Neck Strap (JRPA023). The eye hook is precisely positioned (see Section 1.1) so

that the transmitter will be perfectly balanced when a neck strap is used.



2.1 INSTALLATION REQUIREMENTS

Please read and carefully follow these suggestions.

1. For added protection, wrap the RX and the RX Ni-Cd in foam rubber that is at least 1/4" thick.
2. Run the RX antenna through the fuselage and make sure it is fully extended. Never cut or bundle your RX antenna—this will decrease range and performance.
3. Rubber servo grommets are included with your radio system and should be installed in the servo flanges. The servos should then be mounted on either hardwood rails or a plywood tray with the mounting screws provided. **Do not overtighten the mounting screws.** The flange of the brass eyelets should face down (toward the wood).
4. All servos must be able to move freely over the full range of their travel. Make sure the linkages do not impede servo travel. A stalled servo will drain the battery pack within a few minutes.
5. Before installing servo output arms, make sure the servo is in its neutral position.
6. In the case of gas-powered model aircraft, mount the receiver power switch on the side of the fuselage opposite the muffler to protect the switch from exhaust residue. With other types of models, mount the switch in the most convenient place. Make sure that the switch operates freely and is capable of traveling its full distance.
7. **With your model on the ground and the transmitter antenna collapsed, check that your system works at a distance of 75 to 100 feet.** If your system stops functioning at a distance that is shorter than listed above, please contact the Horizon Service Center for further information prior to flying your model.

2.2 CONNECTIONS

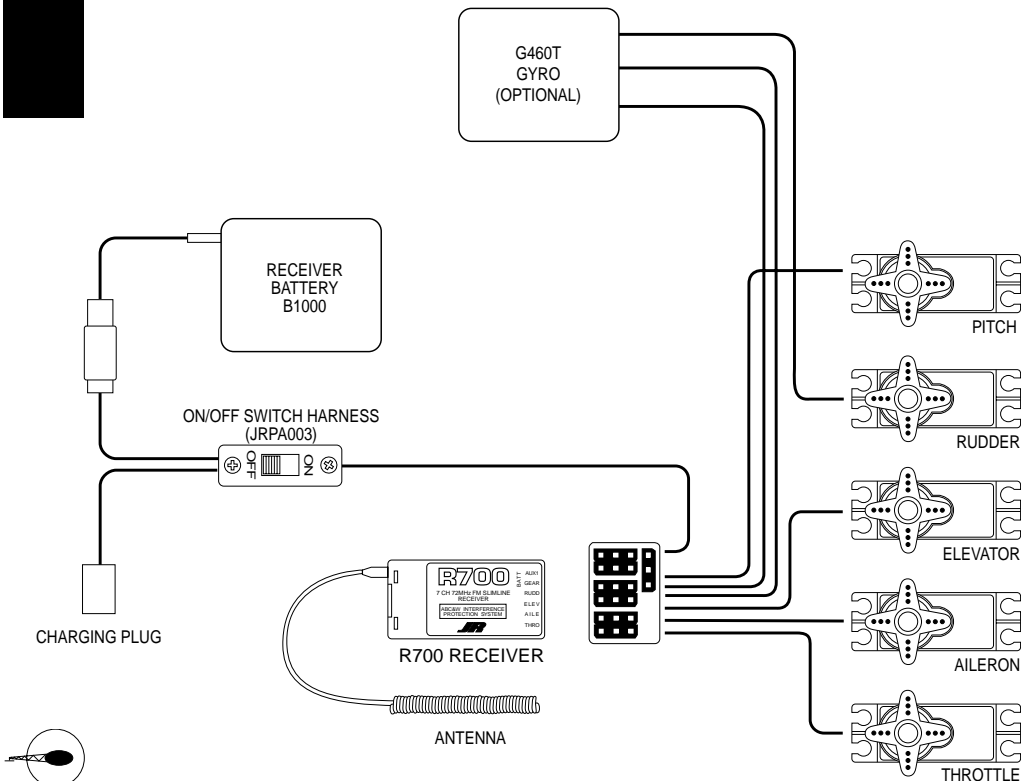

3

KEY INPUT AND DISPLAY

Two input keys are located at the lower right and left faceplate of the XP662 transmitter. The keys are used to access and program the transmitter. Each key can be moved up or down using your thumbs.

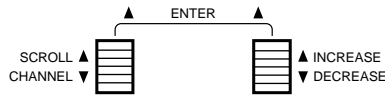

Left button up.....SCROLL — Used to advance through the menus
Left button down...CHANNEL — Used to advance through the channels or features in a given function

Right button up.....INCREASE — Increases value or changes setting (e.g., Reverse Normal)
Right button down...DECREASE — Decreases value or changes setting. (e.g., Reverse Normal)

CHAPTER 4: BATTERY ALARM AND DISPLAY • Helicopter

4

BATTERY ALARM AND DISPLAY

When the transmitter battery drops below 9.0 volts, the display will start to flash BAT and an audible alarm will sound for eight beeps. These warnings mean you should land your aircraft immediately.

Note: During the period that the battery alarm is flashing, the input buttons will not function. If you are currently in the function mode, the transmitter will exit automatically and return to the normal display (see Section 5.1).

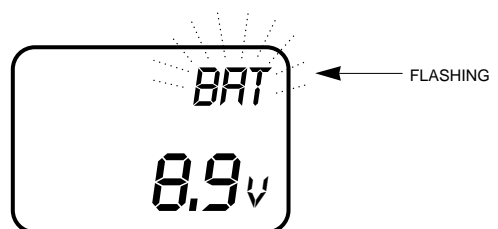

5.1 NORMAL DISPLAY

When the power switch is turned on, the screen will read as shown here in the diagram. This screen is referred to as the normal display.

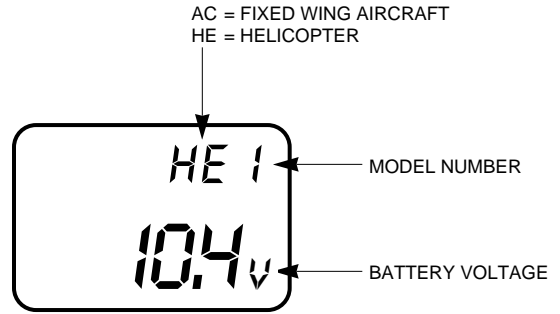

5.2 SYSTEM MODE

To enter the System mode, press the SCROLL and INCREASE buttons simultaneously while you turn on the transmitter. You can now select any of eight system mode functions shown here in the flow chart. To exit the System mode, press the SCROLL and INCREASE buttons simultaneously or turn off the transmitter. Press the SCROLL button to move through the system mode functions. Information for each function is located on the page number listed next to the function name.

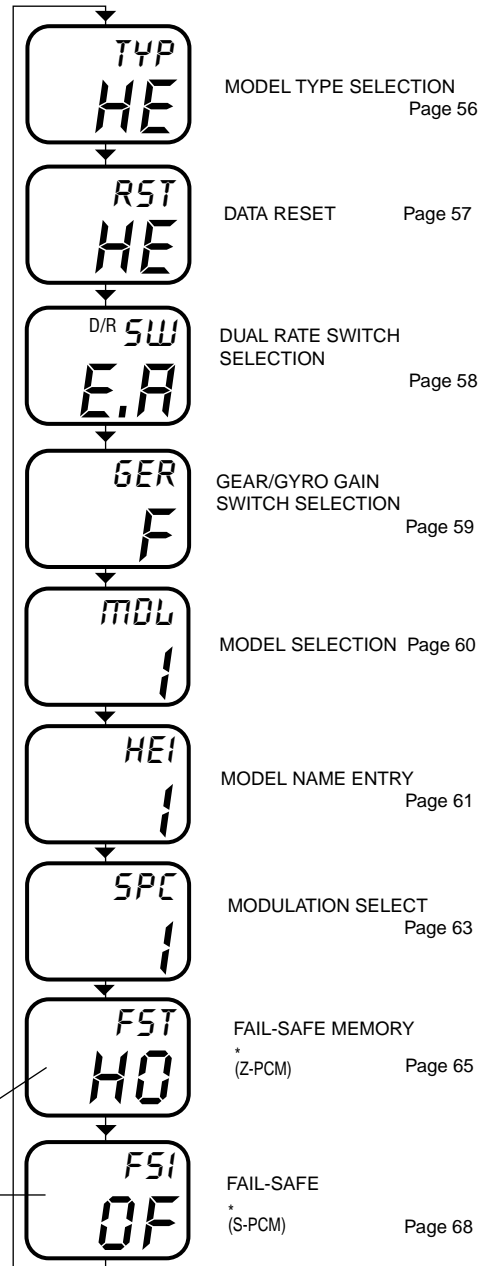

Only visible when modulation type is selected for SPCM or ZPCM
PCM modulation is selected



5.3 FUNCTION MODE

To enter the Function mode, turn on the transmitter. Press the SCROLL and INCREASE buttons simultaneously until a beep is heard. The display will change accordingly and show the last active function. Press the SCROLL button to scroll down through the functions one by one as shown in the flowchart at right. Once the appropriate function is selected, use the CHANNEL button to select the appropriate channel. Use the INCREASE and DECREASE buttons to adjust the values displayed on the screen.

Only visible when throttle hold function is activated

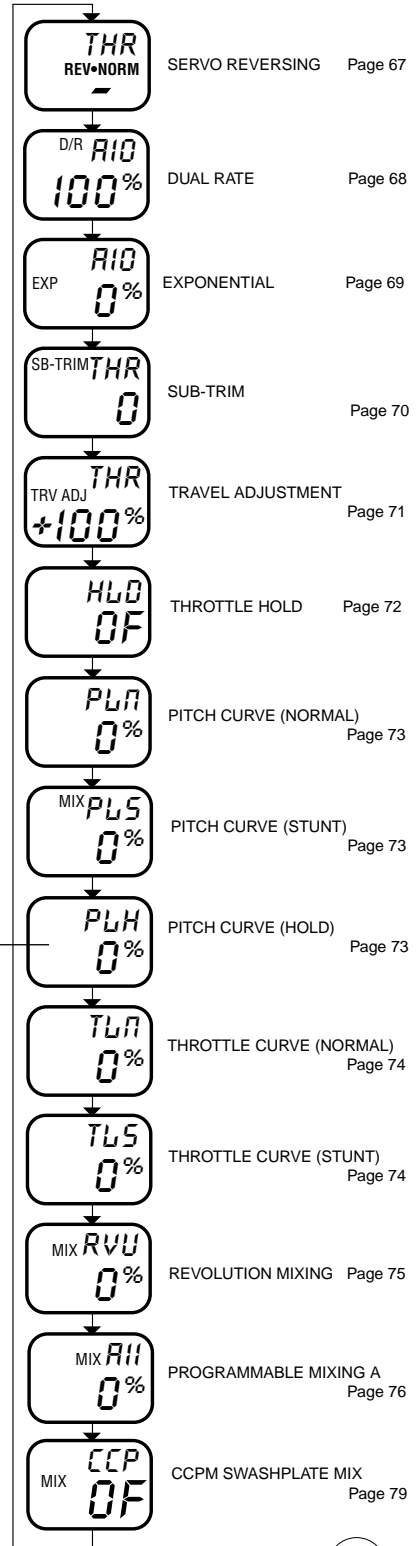

6.1

MODEL TYPE SELECTION

Two types of aircraft programming are available with the XP662, airplane (AC) and helicopter (HE). When you enter the model type selection function, the current model type will appear on the screen. (The current model type being the factory preset or the last model used.) When you press the increase or decrease button to change the model type, the new

model type indicated on the screen will flash. For example, if the current model type is AC and you change to HE, "HE" will flash on the screen. The flashing alerts you to the change of model type and will stop once you move to the next function or exit the system mode.

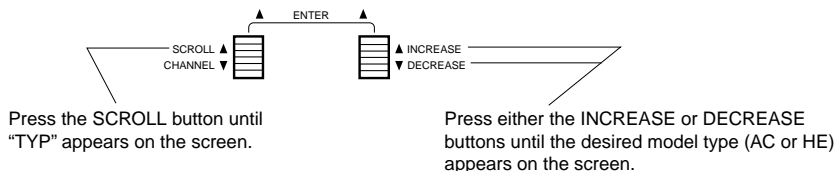
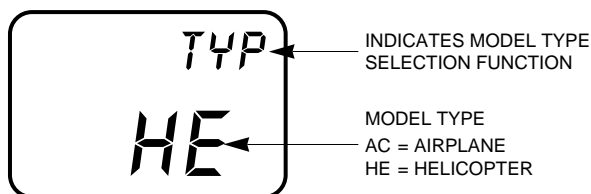

Accessing the Model Type Selection Function

1. Press the SCROLL and INCREASE buttons simultaneously and hold.
2. Turn on the transmitter to enter the system mode.
3. Press the SCROLL button until "TYP" appears on the screen.
4. Press the INCREASE or DECREASE button until the desired model type appears on the screen (AC = airplane HE = helicopter).
5. Press the SCROLL button to access the Data Reset function.
6. To exit, press the SCROLL and INCREASE buttons simultaneously.



6.2 DATA RESET

The Data Reset function allows you to reset all the programming in the selected model (1-6) to the factory settings. Before using the data reset function it is important to enter the Model Selection function

and check that the current model number (1-6) indicated is the model that you want to reprogram to the factory settings. The model selection function is described in Section 6.5.

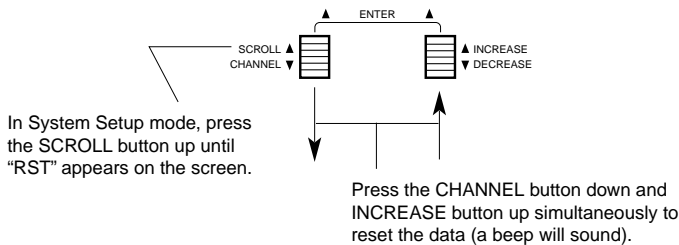
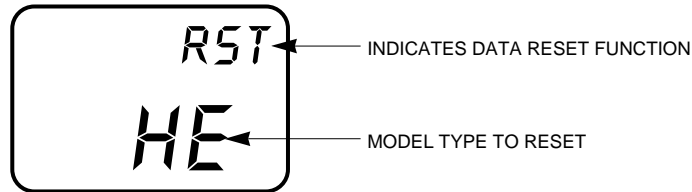

Accessing the Data Reset Function

1. Press the SCROLL and INCREASE buttons simultaneously and hold.
2. Turn on the transmitter to enter the system mode.
3. Press the SCROLL button until "RST" appears on the screen.
4. Press the CHANNEL and INCREASE buttons simultaneously to reset the data. (To confirm that the selected model's programming has been reset, a beep will sound and the "AC" or "HE" will momentarily disappear from the screen.)
5. Press the SCROLL button to access the Dual Rate switch selection function.
6. To exit, press the SCROLL and INCREASE buttons simultaneously.



6.3

DUAL RATE SWITCH SELECTION

The dual rate switch position is selectable and the elevator and aileron dual rates can be combined on one switch. This allows a single switch to be used when moving from high rates for wild maneuvers to low rates for mild maneuvers. Exponential Rate (EXP) is also available for both aileron and elevator and

works in conjunction with the dual rate function to provide mild control movements around neutral while allowing maximum servo travel. This reduces sensitivity in the middle portion of the stick control and still allows full travel at the end of the stick control. Refer to section 7.3 for exponential rate adjustment.



INDICATES DUAL RATE SWITCH FUNCTION

INDICATES SWITCH POSITION

E.A = ELEVATOR AND AILERON OPERATE INDIVIDUALLY

A. = OPERATION OF ELEVATOR AND AILERON DUAL RATE ON AILERON DUAL RATE SWITCH

E. = OPERATION OF ELEVATOR AND AILERON DUAL RATE ON ELEVATOR DUAL RATE SWITCH

CF = OPERATION OF ELEVATOR AND AILERON DUAL RATE ON FLIGHT MODE SWITCH

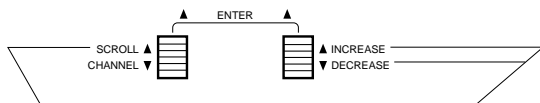

Press the SCROLL button until "D/R SW" appears on the screen.

Press either the INCREASE or DECREASE buttons until the desired switch position appears on the screen.

Accessing the Dual Rate Switch Selection Function

1. Press the SCROLL and INCREASE buttons simultaneously and hold.
2. Turn on the transmitter to enter the system mode.
3. Press the SCROLL button until "D/R SW" appears on the screen.
4. Press the INCREASE or DECREASE button until the desired switch position or "CF" for "VTR" appears on the screen. To adjust the dual rate values see Section 7.2.
5. Press the SCROLL button to access the Ger/Gyro Switch Selection function.
6. To exit, press the SCROLL and INCREASE buttons simultaneously.



6.4

GEAR/GYRO SWITCH SELECTION

The XP662 gear/gyro switch selection function enables the dual rate values of the gyro to be combined with one of four switches (flight mode, throttle hold, aileron dual rate, elevator dual rate). This feature is for use with gyros that offer a dual rate sensitivity adjustment, such as the JR G460T Piezo

Gyro (JRP460T). The most common use for this feature would be to combine the gyro dual rate adjustment with the flight mode switch. This would then automatically alter the gyro sensitivity from normal (hover) to flight (forward flight) when the flight mode switch is in use.

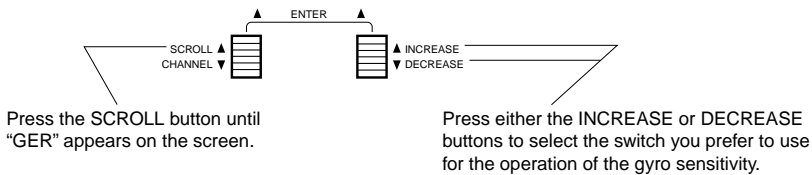
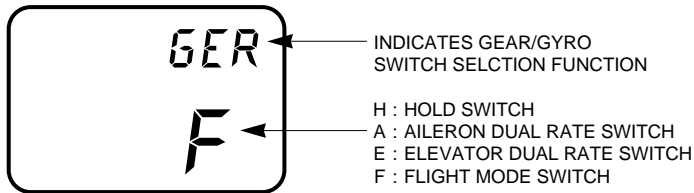

Accessing the Gear/Gyro Switch Selection Function

1. Press the SCROLL and INCREASE buttons simultaneously and hold.
2. Turn on the transmitter to enter the system mode.
3. Press the SCROLL button until "GER" appears on the screen.
4. Press the INCREASE or DECREASE button to select the switch you prefer to use for the operation of the gyro sensitivity.
5. Press the SCROLL button to access the Model Selection function.
6. To exit, press the SCROLL and INCREASE buttons simultaneously.

Note: The remote gain lead from the gyro should be plugged into channel 5 (gear) of the receiver.



6.5 MODEL SELECTION

The XP662 has memory for six models. It can store the settings for six airplanes, six helicopters or three airplanes and three helicopters, etc.

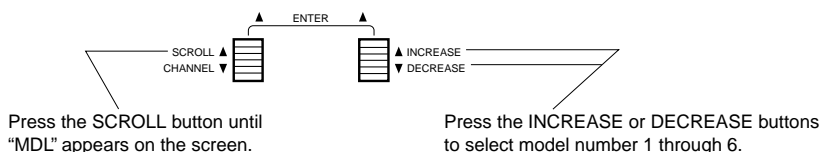
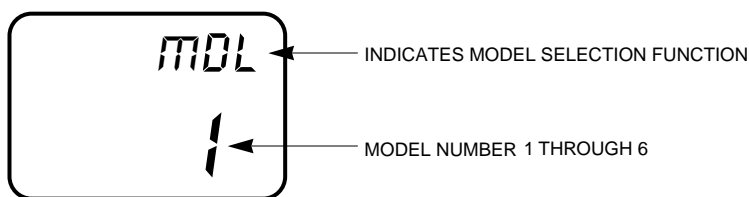

Accessing the Model Selection Function

1. Press the SCROLL and INCREASE buttons simultaneously and hold.
2. Turn on the transmitter to enter the System mode.
3. Press the SCROLL button until "MDL" appears on the screen.
4. Press the INCREASE or DECREASE button to select model numbers 1 through 6.
5. Press the SCROLL button to access the Model Name entry function.
6. To exit, press the SCROLL and INCREASE buttons simultaneously.



6.6

MODEL NAME ENTRY

The XP662 allows a 3-digit name to be input for each of the six models available. The current model will be displayed in the normal display. This feature is

useful to help identify different aircraft types, or model setups.

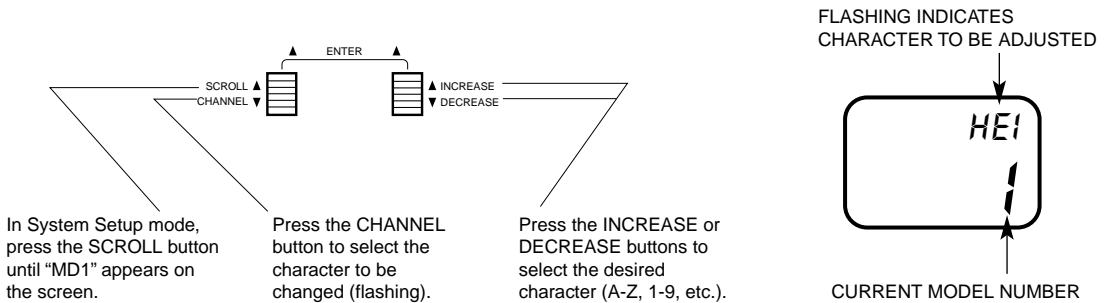

Accessing the Model Name Entry Function

1. Press the SCROLL and INCREASE buttons simultaneously and hold.
2. Turn on the transmitter to enter the System mode.
3. Press the SCROLL button until "AC1" appears on the screen.
4. Press the INCREASE or DECREASE buttons to select the correct letter/number for the first character (flashing).
5. To adjust the remaining two characters, press the CHANNEL button until the desired character to be adjusted is flashing.
6. Press the SCROLL button to access the Modulation Select function.
7. To exit, press the SCROLL and INCREASE buttons simultaneously.



6.7 MODULATION SELECT

The modulation select function enables your XP662 to transmit to a variety of JR receivers that are already, or may soon be, in existence. You can select from either PPM (FM), Z-PCM or S-PCM, depending on the central processing unit within your receiver to utilize existing receivers, or to upgrade your XP662 flight pack for future models. Your system comes factory preset in the FM or PPM (Pulse Position Modulation) position so that it is compatible with the included R700 FM receiver.

Please refer to the receiver compatibility chart below when selecting the modulation type for various JR receivers.

Note: Once the proper modulation has been selected for a specific model number, the modulation type will remain the same for that model number, even during model number/type changes. In other words, if you have one model on FM/PPM and one model on PCM, the system will automatically change modulation types once the correct modulation has been selected for that model.

| TX Modulation | Compatible Receivers | # of Channels & Brief Description | TX Modulation | Compatible Receivers | # of Channels & Brief Description |
|---------------|----------------------|-----------------------------------|---------------|-----------------------------|-----------------------------------|
| PPM (FM) | NER-226 | 6 (micro) | Z-PCM | NER-236 | 6 (micro) |
| PPM (FM) | NER-228 | 8 | Z-PCM | NER-627XZ or 627 "G" series | 7 |
| PPM (FM) | NER-327x | 7 | Z-PCM | NER-J329P | 9 |
| PPM (FM) | NER-527x | 7 (micro) | Z-PCM | NER-910XZ | 10 |
| PPM (FM) | NER-529x | 9 (micro) | S-PCM | NER-D940S | 10 |
| PPM (FM) | NER-549 | 9 | S-PCM | NER-649S | 9 |
| PPM (FM) | NER-600 | 6 (micro) | S-PCM | NER-950S | 10 |
| PPM (FM) | NER-700 | 7 (Slimline) | | | |

Accessing the Modulation Select Function

1. Press the SCROLL and INCREASE buttons simultaneously and hold.
2. Turn on the transmitter to enter the System mode.
3. Press the SCROLL button until "PPM" appears on the screen.
4. Press either the INCREASE or DECREASE buttons to change the modulation to the desired setting FM (PPM), Z-PCM (ZPC) or S-PCM (SPC).*
5. Press the SCROLL button to access the Model Type function.
6. To exit, press the SCROLL and INCREASE buttons simultaneously.

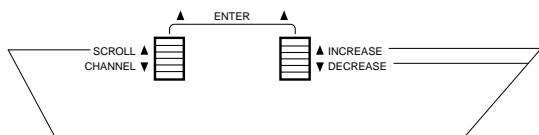

Press the SCROLL button until "PPM" appears.

Press the INCREASE or DECREASE buttons to select the desired modulation.

Note: The modulation for the current model in use can be viewed at a glance by pressing the mode button with the system in the normal screen position.

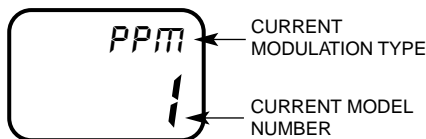

MODULATION TYPES
 PPM (FM)
 SPCM
 ZPCM

Note: If either S-PCM or Z-PCM modulation is selected, pressing the SCROLL button will access the Fail-Safe/Hold function.



6.8

FAIL-SAFE/HOLD

The Fail-Safe/Hold function is available only when you use the XP662 transmitter in either of the PCM modulations: S-PCM or Z-PCM. This function is designed to help minimize damage to your airplane during a loss of signal to the receiver. The servos either assume the fail-safe presets or hold the last good signal position.

Note: In the PCM modulations, the Fail-Safe/Hold function cannot be totally disabled so that the servos will react to interference in the same way as they do in a PPM system. This is only possible with the use of a PPM receiver and the transmitter in the PPM modulation.

Note: Since the actual screen appearance varies, depending on the modulation of your radio, refer to the appropriate modulation section which follows (Z-PCM, S-PCM).

As noted earlier, if you are in the PPM modulation, the Fail-Safe/Hold function is not applicable. Therefore, the Fail-Safe/Hold function will not appear on your LCD in the PPM mode.

Refer to the Modulation Selection section for more information pertaining to the broadcast signal of your XP662 transmitter.

6.9

FAIL-SAFE/HOLD FUNCTION IN Z-PCM MODULATION

Hold (Z-PCM)

The Hold function is automatically activated when the radio is turned on and is in the Z-PCM modulation.

This function stops (or holds) the servos in the positions they were in just prior to the interference. Therefore, your airplane maintains the position held immediately before the interference was experienced.

When a clear signal is restored, the Hold function releases, and control of the airplane returns to you.

If you would prefer your control surfaces to move to a chosen position during a loss of signal, please refer to the time delay/memory section below.

Accessing Fail-Safe/Hold (Z-PCM)

When the Fail-Safe function is activated (i.e., when the signal is interrupted), the transmitter automatically moves each servo to a preset position. The position that each servo assumes is determined by you, as is the time length of interference that must occur before servo movement.

After the interference has ceased, control of the airplane returns immediately to you.

There are three time delays to choose from: 1/3 (0.3) second, 1/2(0.5) second and 1.0 second. These time delays are the amount of time it takes, starting the

moment the interference occurs, until the servos assume their preset positions.

1. Press the SCROLL and INCREASE buttons simultaneously and hold.
2. Turn on the transmitter to enter the System mode.
3. Press the SCROLL button until "FST" appears on the screen.

Note: If "Fail-Safe" does not appear on your LCD, it is because you are transmitting in PPM. Fail-Safe is not applicable in the PPM mode. Refer to the Modulation Mode Selection section for more information.



6.9

FAIL-SAFE/HOLD FUNCTION IN Z-PCM MODULATION (continued)

Setting Fail-Safe/Hold Time Delay/Memory In Z-PCM Modulation

1. After accessing the Fail-Safe function, it is now time to adjust the fail-safe time presets.
2. Select among the three time delays (.3, .5, or 1.0 seconds) by pressing either the (+) or (-) keys until the desired setting appears on the screen.

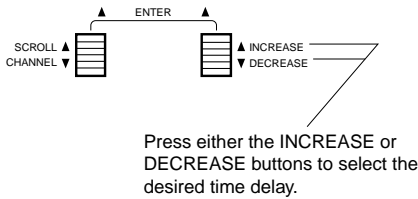

HO = ALL SERVOS HOLD
 0.3 = 1/3 SECOND TIME DELAY
 0.5 = 1/2 SECOND TIME DELAY
 1.0 = 1 SECOND TIME DELAY

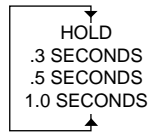

Setting Servo Position Presets

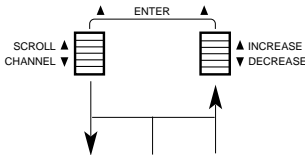

Press the CHANNEL and INCREASE buttons simultaneously to store the fail-safe servo presets.



CL WILL FLASH WHEN FAIL-SAFE SERVO POSITIONS ARE ENTERED.

1. Press the SCROLL button until FSM appears on the screen.

Note: If Hold position (HO) is selected, this function/screen will not be present.

2. Set all controls to the desired fail-safe position, then press the (+) and (-) buttons simultaneously. A high pitch beep sound will confirm that the preset positions have been entered.
3. Hold the transmitter sticks in the position that you want the servos to assume during signal loss conditions. You can determine fail-safe preset positions for the other channels by placing the potentiometers and switches in the positions that you want them to assume during interference.
4. With the sticks, switches and potentiometers in the fail-safe positions, press the CHANNEL and INCREASE keys simultaneously. This will enter these locations as the fail-safe memory settings.

A high-pitched beep will indicate that this setting has been stored.

5. To confirm that the input of data was successful, switch the transmitter OFF. The controls will move to the input locations. If not, repeat Step 4 again.
6. To exit the Fail-Safe function, press the SCROLL and INCREASE buttons simultaneously.

Note: These preset positions remain stored in the transmitter's memory until both the transmitter battery pack and the lithium back-up battery have been removed (or until data reset has been performed). Therefore, you do not have to reset the fail-safe each time you fly. Should you want to re-adjust the fail-safe presets, access the Fail-Safe function and adjust the presets as you have just done. The transmitter automatically recalls the settings for the last fail-safe adjustment.



6.10 FAIL-SAFE/HOLD MEMORY IN S-PCM MODULATION

Hold Function (S-PCM)

The Hold function is automatically activated when the radio is turned on and in the S-PCM modulation.

This function stops (or holds) the servos in the positions they were in just prior to the interference.

Therefore, your aircraft maintains the position held immediately before the interference was experienced. When a clear signal is restored, the hold function releases, and control of the airplane returns to you.

Fail-Safe/Hold Combination in S-PCM Modulation

The XP662 allows you to combine the hold and fail-safe presets for all six channels on the receiver you can select fail-safe or hold independently for all channels on your aircraft. In other words, some channels will hold their last clear signal position, while others assume the preset position. Once the fail-safe has been activated by signal interruption (interference), the transmitter automatically moves

the servos to a preset position. The predetermined servo positions are set by you. In the S-PCM fail-safe, the time delay (the amount of time it takes, starting the moment the interference occurs, until the servos assume the preset positions) is fixed at .3, or 1/3, second.

After the interference has ceased, normal operation of the airplane returns to you immediately.



6.10

FAIL-SAFE/HOLD MEMORY IN S-PCM MODULATION (continued)

Activating Servo Fail-Safe Presets by Channel (S-PCM)

1. Press the SCROLL and INCREASE buttons simultaneously and hold.
2. Turn on the transmitter to enter the system mode.
3. Press the SCROLL button until "FS1" appears on the screen. The #1 on the screen refers to the specific channel (1-6) to be adjusted.
4. Press the INCREASE or DECREASE button to activate (turn on) the preset position function for that channel.
5. Press the CHANNEL button to move to the next channel(s) to be adjusted (2-6). Repeat Step 4 for each channel to be activated.

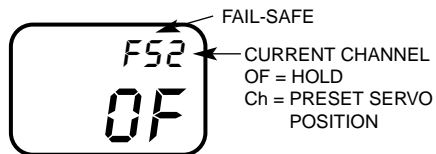
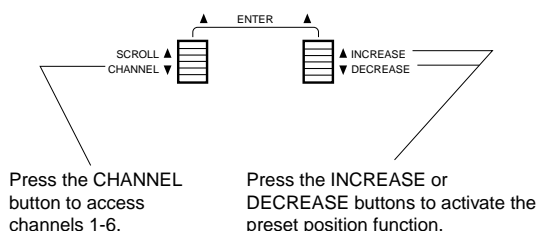

Note: If Hold Position (HO) is selected for all six channels, this Function/Screen will not be present.

Setting Servo Fail-Safe Presets in S-PCM Modulation

1. Press the SCROLL button until "FSM" appears on the screen.
2. Set all controls to the desired Fail-Safe positions. Next press the CBHANNEL and INCREASE button simultaneously. A high-pitch beep sound will confirm that the preset positions have been entered and accepted.

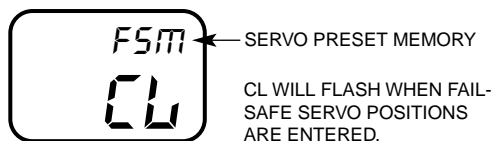
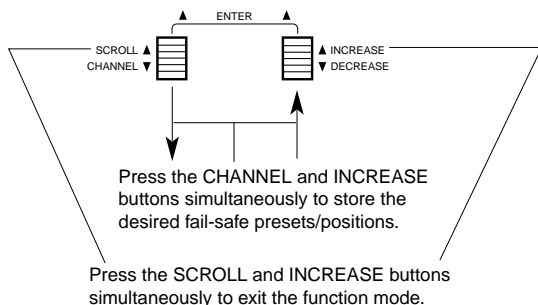

7.1

SERVO REVERSING

Servo reversing is a very convenient function used in the setup of a new aircraft. It is used to change the direction of servo rotation in relation to the

corresponding stick movement. Servo reversing is available for all six channels.

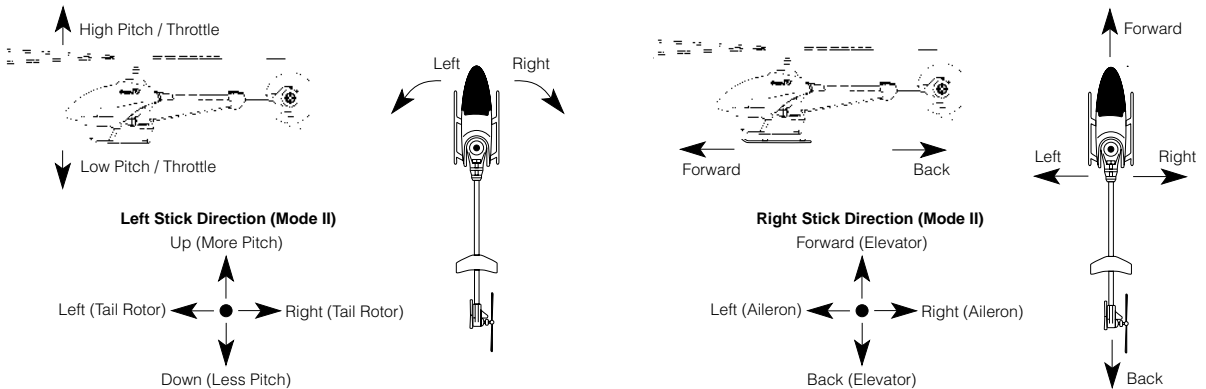
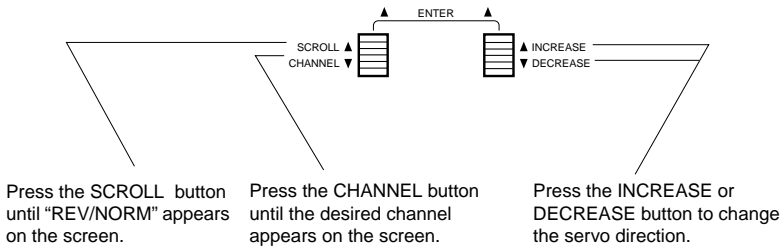
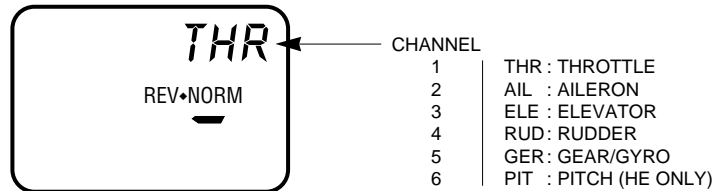

Accessing the Servo Reversing Function

1. Turn on the transmitter.
2. Press the **SCROLL** and **INCREASE** buttons simultaneously to enter the Function mode.
3. Press the **SCROLL** button until "REV-NORM" appears on the screen.
4. Press the **CHANNEL** button until the desired channel appears on the screen.
5. Press the **INCREASE** or **DECREASE** button to change the servo direction.
6. Press the **MODE** button to access the Dual Rate function.
7. To exit, press the **MODE** and **CHANNEL** buttons simultaneously.



7.2 DUAL RATE

Dual rate is available for the aileron and elevator channels. The purpose of this function is to allow for in-flight selection of two preset servo travels for each of these channels. The amount of travel is adjustable from 0-125%. The factory settings for both switch positions (0 and 1) is 100%. Either position may be selected as the low or high rate by placing the switches in the desired position and adjusting the value for that position. Operation of these switches is described in Section 6.3.

Different types of maneuvers require varying amounts of control movements. Snap rolls require large control movements, while smooth maneuvers like long slow rolls are best performed with smaller control movements. Dual rates allow you to change the control movements in flight at the flip of a switch. This allows you to execute maneuvers requiring both radical control movements and small control movements during a single flight.

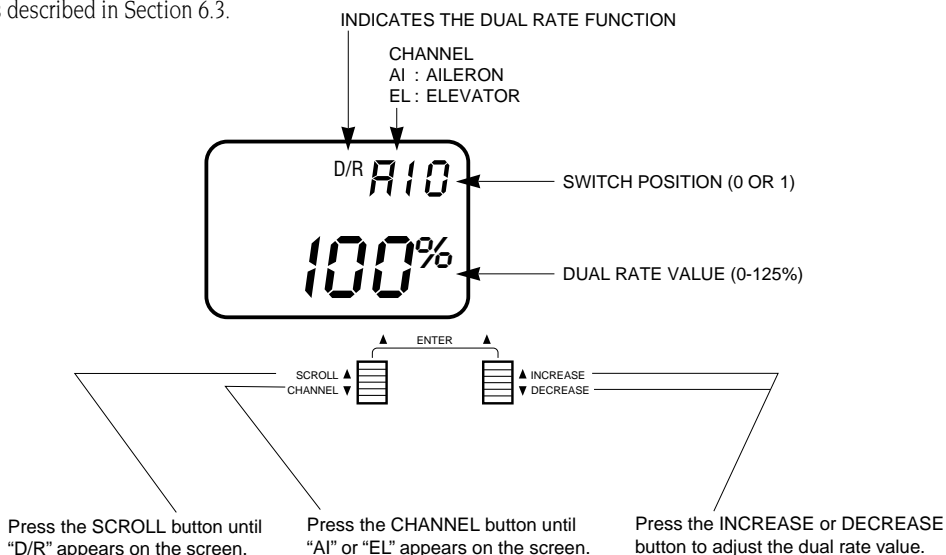

Accessing the Dual Rate Function

1. Turn on the transmitter.
2. Press the SCROLL and INCREASE buttons simultaneously to enter the function mode.
3. Press the SCROLL button until "D/R" appears on the screen.
4. Press the CHANNEL button until the desired channel appears on the screen (AI = aileron or EL = elevator).
5. The number that appears directly to the right of the selected channel is the switch position. There are two switch positions, 0 and 1, for each of the channels. A "0" will appear when the selected dual rate switch is in the uppermost position and a "1" when the selected switch is in the lower position.
6. To change the switch selection you must enter the dual rate switch selection function in the system mode (see Section 6.3).
7. The number in the center of the screen indicates the current dual rate value for the selected switch position and channel. Press the INCREASE or DECREASE button to adjust the dual rate value (0-125%).
8. After adjusting the value for the 0 switch position, change to the 1 switch position and adjust the rates.
9. Press the CHANNEL button to select the other channel and adjust the dual rate value for both switch positions.
10. Press the SCROLL button to access the exponential rate feature.
11. To exit, press the SCROLL and INCREASE buttons simultaneously.



7.3

EXPONENTIAL

Programmable exponential adjustments are offered on the aileron and elevator channels of your XP662 system. Exponential is a function that allows you to tailor the response rate of the controls as compared to the stick inputs. The purpose of exponential is to reduce the sensitivity in the middle portion of stick movement, while still allowing full travel at the end of the stick movement. In other words, the end result (travel) remains the same, although exponential changes the rate at which it achieves this travel.

The adjustable range of the Exponential function is from 0–100%. Zero percent (0%) is linear stick control which means that the response rate is equal

throughout the stick control. One hundred percent (100%) is full exponential. The larger the exponential value, the less servo action, or sensitivity, you will notice around the neutral setting.

Note: The Exponential function operates in conjunction with the Dual Rate function. It is imperative to understand the Dual Rate Function prior to adjusting the exponential values.

Exponential may be selected independently for either the high or low rate (position 0 or 1) or both.

Note: The dual rate switch position is changed/ accessed by setting the appropriate dual rate switch to the 0 or 1 positions.

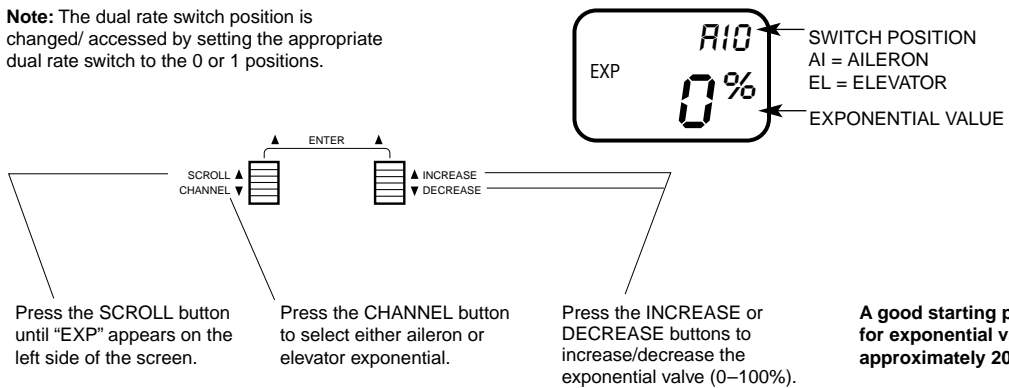

Accessing the Exponential Function

1. Turn on the transmitter.
2. Press the SCROLL and INCREASE buttons simultaneously to enter the Function mode.
3. Press the SCROLL button until "EXP" appears at the left side of the screen.
4. Press the CHANNEL button until the desired channel appears on the screen (AI or EL).
5. Using the appropriate dual rate switch, select the correct position to be adjusted (0 or 1).
6. Press the INCREASE or DECREASE buttons to increase/decrease the exponential value.
7. Press the SCROLL button to access the Sub-Trim function.
8. To exit, press the SCROLL and INCREASE buttons simultaneously.



7.4 SUB-TRIM

Sub-trim is an electronic trim that is available for each of the six channels. Sub-trim is particularly useful as it allows the mechanical trim levers to be returned to their neutral positions by adjusting /changing the servo's neutral position electronically, without the need to mechanically adjust the specific control linkage. This allows the same mechanical trim lever settings between the five models you can

control with this radio system. Sub-trim can also allow additional trim travel when mechanical trims do not provide enough movement.

Note: It is recommended to use as little subtrim as possible for adjustment. If more that 20–30 points are required, is it suggested that a mechanical linkage adjustment be performed.

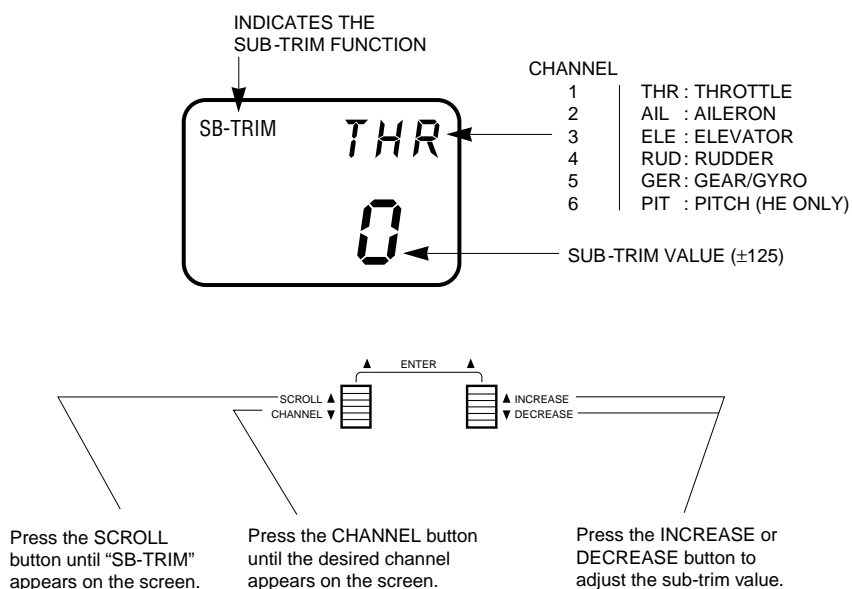

Accessing the Sub-Trim Function

1. Turn on the transmitter.
2. Press the SCROLL and INCREASE buttons simultaneously to enter the function mode.
3. Press the SCROLL button until "SB-Trim" appears on the screen.
4. Press the CHANNEL button until the desired channel appears on the screen.
5. Press the INCREASE or DECREASE button to establish the desired amount of sub-trim.
6. Press the SCROLL button to access the Travel Adjustment function.
7. To exit, press the SCROLL and INCREASE buttons simultaneously.



7.5

TRAVEL ADJUSTMENT

The amount of servo travel is adjustable for each direction for each of the 6 channels individually. The adjustment range is from 0% to 150%. Travel adjustment is factory set at 100% for all channels. The travel adjustment value displayed on the screen depends on the position of the stick or switch (e.g., flap switch, gear switch). This function is useful

either to maximize control surface travel or to reduce travel to eliminate servo binding without the need for mechanical adjustment.

This function is also used to remove unwanted pitch-to-cyclic coupling when in CCPM Swashplate Mix mode (see page 84).

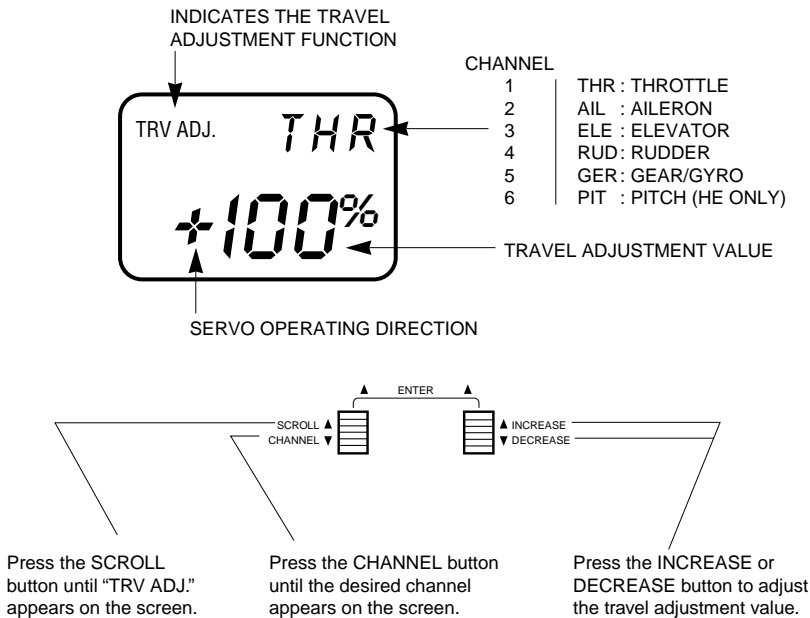

Accessing the Travel Adjustment Function

1. Turn on the transmitter.
2. Press the SCROLL and INCREASE buttons simultaneously to enter the function mode.
3. Press the SCROLL button until "TRV ADJ." appears on the screen.
4. Press the CHANNEL button until the desired channel appears on the screen.
5. Move the selected channel stick or switch in the direction that you want to adjust the travel. Press the INCREASE or DECREASE button to achieve the desired travel. Move the stick in the opposite direction to adjust the travel in the opposite direction.
6. The same may be done for all channels.
7. Press the SCROLL button to access the throttle hold function.
8. To exit, press the SCROLL and INCREASE buttons simultaneously.



7.6 THROTTLE HOLD

The throttle hold function enables the throttle servo to be held in a specific location, while allowing the collective pitch servo to move independently with the throttle stick. The purpose of this function is for practicing autorotation landings with the helicopter's engine at idle. When the throttle hold switch is

changed from off to activated, there will be a third adjustable pitch curve added to the pitch curve function. The throttle hold switch is located on the top right rear corner of the transmitter. The throttle hold is on in the forward position. In the back position, the throttle hold function is off.

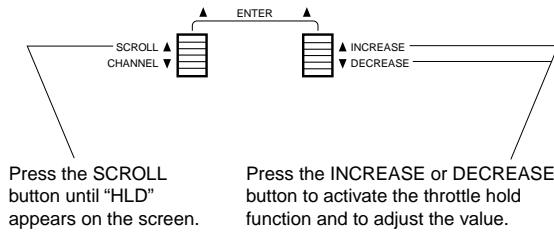
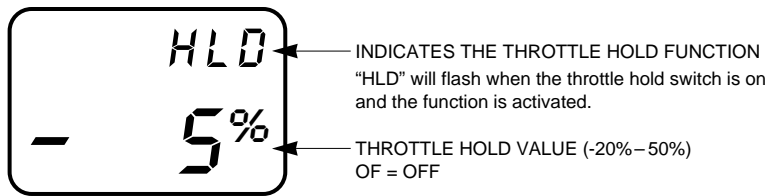

Accessing the Throttle Hold Function

1. Turn on the transmitter.
2. Press the SCROLL and INCREASE buttons simultaneously to enter the Function mode.
3. Press the SCROLL button until "HLD" appears on the screen.
4. The factory setting for the Throttle Hold function is off. **Note:** When the Throttle Hold function is off, the throttle hold pitch curve will not appear in the pitch curve function. Press the INCREASE or DECREASE button to activate the Throttle Hold function. The throttle hold pitch curve will now appear in the pitch curve function. To inhibit the Throttle Hold function, press the CHANNEL and INCREASE buttons simultaneously.
5. Using the INCREASE or DECREASE button, adjust the throttle hold value to deliver a reliable engine idle speed. To do this, set the throttle trim to your normal starting idle setting (1/2, 3/4, etc.). Next, with the engine off, adjust your throttle hold value so that, when you change the throttle hold from on to off, there is no movement of the servo arm. The normal range of throttle hold is from -2 (1/2 trim) to +15 (full high trim).
6. Press the SCROLL button to access the pitch curve function.
7. To exit, press the SCROLL and INCREASE buttons simultaneously.



7.7

PITCH CURVE

The XP652 offers three separate pitch curves with three adjustable reference points per curve. This function allocates a separate pitch curve setting during Normal, Stunt, and Throttle Hold modes to maximize flight performance. Once the pitch curves are established, each can be activated in flight using the two-position flight mode switch and the throttle hold switch.

Each of the three reference points of the pitch curve are independently adjustable from 0–100%. These three points correspond to the low, middle, and high positions of the throttle stick (collective).

The graph below shows samples of pitch curves in the Normal (N), Stunt (S) and Throttle Hold (H) conditions. The factory preset values for all three pitch curves are: Low 0%, Middle 50%, and High 100%.

POINT DISPLAY/STICK POSITION
 L: LOW 0%
 2: CENTER 50%
 H: HIGH 100%

SWITCH POSITION
 Flashing when switch position and display are the same.
 N: NORMAL
 S: STUNT
 H: HOLD
 Only visible when hold function is activated.

PITCH CURVE VALUE (0-100%)

Press the **SCROLL** button until "PLN" appears on the screen. Press again to access Stunt, Hold or Throttle Curve.

Press the **CHANNEL** button to select the desired point display/stick position.

Press the **INCREASE** or **DECREASE** button to adjust the pitch curve value.

PLN

PITCH CURVE
LOW STICK
NORMAL MODE

P2N

PITCH CURVE
HALF STICK
NORMAL MODE

PHN

PITCH CURVE
HIGH STICK
NORMAL MODE

PLS

PITCH CURVE
LOW STICK
STUNT MODE

P2S

PITCH CURVE
HALF STICK
STUNT MODE

PHS

PITCH CURVE
HIGH STICK
STUNT MODE

Accessing the Pitch Curve Function

1. Turn on the transmitter.
 2. Press the **SCROLL** and **INCREASE** buttons simultaneously to enter the Function mode.
 3. Press the **SCROLL** button until "PLN" appears on the screen. The letter to the far right indicates the specific pitch curve section that you are in (N, S or H). The letter in the center indicates the reference point that you are in (L, 2 or H).
 4. Press the **CHANNEL** button to select the reference point of the pitch curve you want to change.
 5. Press the **INCREASE** or **DECREASE** button to change the value of the current reference point. The range of each point is 0–100% in 1% intervals.
 6. To set the pitch curve for the stunt (flight) mode, press the **MODE** button once. Repeat Step 5 and Step 6 to adjust.
 7. To set the pitch curve for the throttle hold mode, press the **MODE** button once. Repeat Step 5 and Step 6 to adjust.
 8. Press the **MODE** button to access the throttle curve function.
- Note:** If throttle hold is not activated, the Throttle Curve function will be accessed.
9. To exit, press the **MODE** and **CHANNEL** buttons simultaneously.



7.8 THROTTLE CURVE

Adjustment of the throttle curve is very similar to the pitch curve adjustment described in the preceding section. A thorough understanding of the pitch curve section will make the throttle curve section easier to understand.

There are two independent types of throttle curves available—normal and stunt. The normal or hover throttle curve has three reference points (L, 2, H) and the stunt or flight throttle curve has two reference points (L and 2).

The two throttle curves are activated by the flight mode switch located on the top left rear corner of the transmitter. The throttle curve is in the normal condition when the flight mode switch is in the back position. The throttle curve is in the stunt condition when the flight mode switch is in the forward position.

Note: In Stunt mode (S), the high position of the throttle curve is preset to 100%, and is not adjustable.

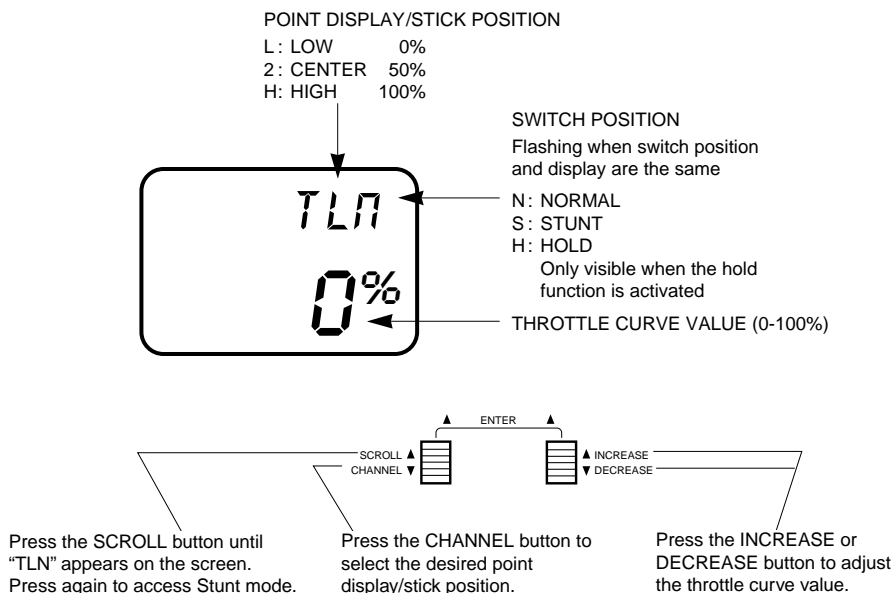

Accessing the Throttle Curve Function

1. Turn on the transmitter.
2. Press the SCROLL and INCREASE buttons simultaneously to enter the function mode.
3. Press the SCROLL button until "TLN" appears on the screen. The letter to the far right indicates the specific throttle curve section that you are in (N, S, or H). The letter in the center indicates the reference point that you are in.
4. Press the CHANNEL button to select the reference point of the throttle curve you want to change (L, 2, or H*).
5. Press the INCREASE or DECREASE button to change the value of the current reference point. The range of each point is 0–100% in 1% intervals.
6. To set the throttle curve for the stunt (flight) mode, press the SCROLL button once. Then, repeat Steps 5 and 6 to adjust.
7. Press the SCROLL button once to access the Revolution Mixing function.
8. To exit, press the SCROLL and INCREASE buttons simultaneously.



* Normal mode only.

7.9

REVOLUTION MIXING (Non-Heading Lock Gyros Only)

The Revolution Mixing function combines tail rotor input with the throttle/collective function to counteract the torque created by the main rotor blades. When properly adjusted, the helicopter will climb and descend without a tendency to yaw in either direction. Revolution mixing is for use with non heading lock gyros only.

Since the torque created by the main rotor blades varies with different throttle/pitch settings, it is necessary for the tail rotor blades to change pitch at the same time. The "U" or up mixing adjusts the tail rotor compensation from the mid to high throttle stick setting. The "D" or down mixing adjusts the tail rotor compensation from the mid to the low throttle stick setting.

Thus, if you were to move the throttle from the low to high positions, the tail rotor servo will move from the "D" to the "U" settings.

Revolution Mixing Set-up Procedure

First, set up the helicopter so that it will maintain a stable hover with the tail rotor trim in the center position. Next, bring the helicopter into a steady vertical climb. The body of the helicopter will move in the opposite direction to the main rotor rotation. Increase the "U" or up mixing until the helicopter climbs without the tendency to rotate. At a safe altitude, reduce the throttle. The helicopter will descend, and the body will turn in the same direction as the main rotor blades. Increase the "D" or down mixing until the helicopter descends without the tendency to rotate.

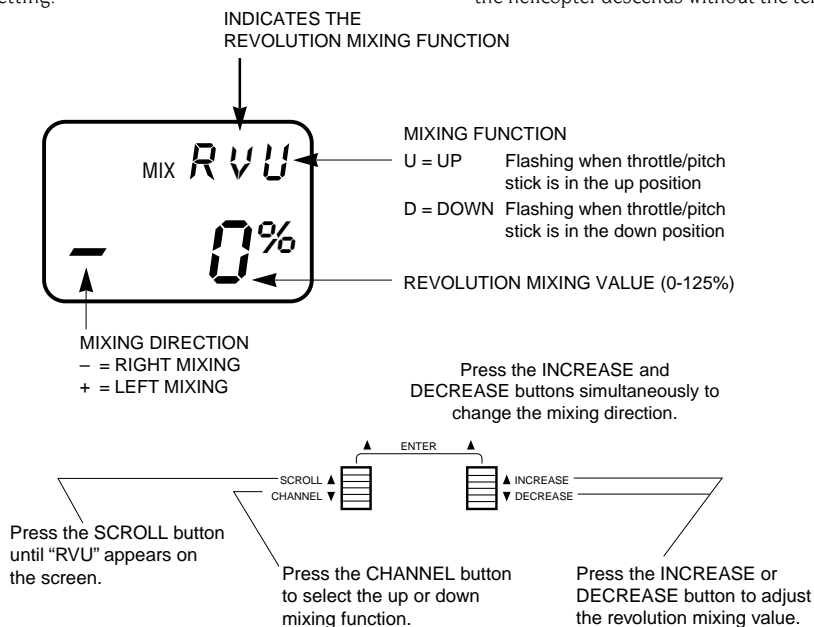

Accessing the Revolution Mixing Function

1. Turn on the transmitter.
2. Press the SCROLL and INCREASE buttons simultaneously to enter the Function mode.
3. Press the SCROLL button until "RVU" appears on the screen.
4. Press the CHANNEL button to select the up or down Mixing function.
5. Press the INCREASE or DECREASE button to adjust the mixing value of the applicable function.
6. Press the SCROLL button to access the Programmable Mix A function.
7. To exit, press the SCROLL and INCREASE buttons simultaneously.



7.10 PROGRAMMABLE MIXING (A)

The XP662 in Helicopter mode offers one (1) programmable mix to be used for a number of different purposes. The functions allow mixing any one channel to any other channel.

The mix can remain on at all times or be switched off in flight using a number of different switches. (Refer to Chart A). Each channel is identified by channel numbers 1-6 (i.e., 2 = aileron, 4 = rudder, etc. —see Chart B) The channel appearing first is known as the Master Channel or the channel to which you want to mix. The second channel is known as the Slave Channel or the channel that is being mixed into the Master Channel. For example, “ELEV-AILE” would indicate elevator-to-aileron mixing each time the

elevator stick is moved, the elevator will deflect, and the aileron will automatically move in the direction and to the value input. Mixing is proportional, so small inputs of the master channel will produce small outputs of the slave channel. Each programmable mix has a mixing “offset.” The purpose of the mixing offset is to redefine the neutral position of the slave channel.

The elevator-aileron mix mentioned above is most commonly used to help trim the helicopter for proper “loop tracking.” This type of mix should be used only by pilots who are comfortable with their programming abilities with the XP662.

Chart A Switch Selection

| SWITCH | MIX A |
|----------------------------------|-------|
| Always ON | ON |
| Flight Mode Switch Position 1 ON | F1 |
| Flight Mode Switch Position 0 ON | F0 |
| Throttle Hold Switch | H |

Chart B Channel Numbers

| CHANNEL NUMBER | FUNCTION |
|----------------|--------------|
| 1 | Throttle |
| 2 | Aileron |
| 3 | Elevator |
| 4 | Rudder |
| 5 | Gear |
| 6 | Pitch (AUX1) |

Accessing the Programmable Mixing Function

1. Turn on the transmitter
2. Press the SCROLL and INCREASE buttons simultaneously to enter the Function mode.
3. Press the SCROLL button until “MIX A11” appears at the top right corner of the screen. This is program mix A.



Press the SCROLL button until “MIX A11” appears.

CURRENT MIX CHANNELS

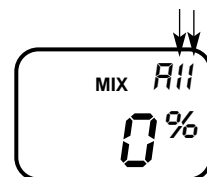

6.20

PROGRAMMABLE MIXING (A) (continued)

Assigning Channels

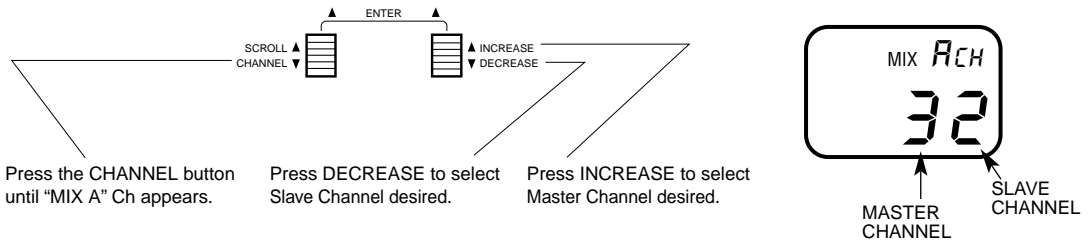

1. Press the CHANNEL button twice until "MIX A CH" appears on the screen.
2. Press the INCREASE button to select the desired "Master Channel" (1-6).
3. Press the DECREASE button to select the desired "slave channel" (1-6). Refer to Chart B on the preceding page for channel number clarification.

Switch Selection

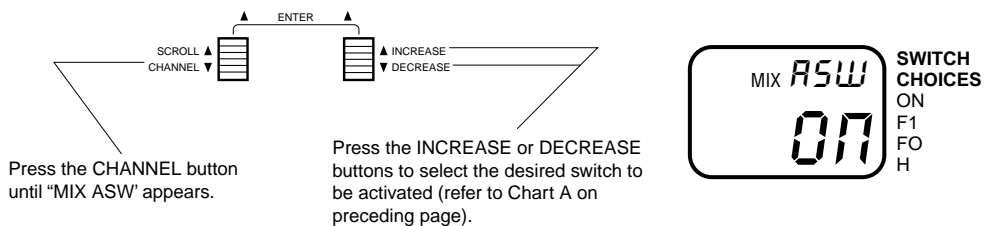

1. Press the Channel button once until "MIX ASW" appears.
 2. Press the INCREASE or DECREASE button to select the desired switch to be used to activate the mixing or leave as on if a constant mix is desired.
- (Refer to Chart A on the preceding page for possible mix/switch selections.)



7.10 PROGRAMMABLE MIXING (A) (continued)

Mixing Value Adjustment

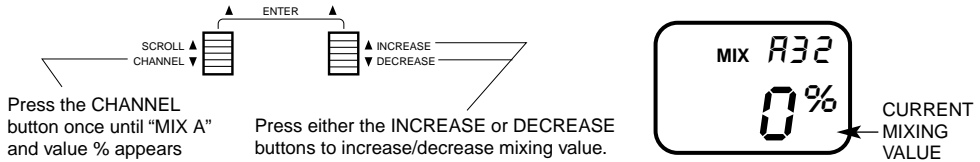

1. Press the Channel button once until "Mix A" appears, with the mixing value located at the bottom of the screen.
2. To set the slave channels mixing value, move and hold the master channel control stick to the direction to be adjusted (up/down—left/right), then press the INCREASE key to add positive mixing value or the DECREASE key to add negative mixing value (+/-125%). When the

master channels stick is moved, the display will automatically show the mixing value for the current stick direction.

Note: If a mix switch position other than on is selected, it will be necessary to move the selected switch to the on, or active, position to adjust the mixing value. "OF" will appear on the screen if the selected mixing switch is in the off position.

Mixing Offset Adjustment

The purpose of the mixing offset feature is to redefine the neutral position of the slave channel to be mixed. Any desired position may be selected for the offset reference point. To set the offset position, place the master channel's stick to the desired position and press either the INCREASE or DECREASE buttons.

This position is now stored in the memory and its offset value from the neutral position of the master channel is indicated numerically on the LCD display. Then, the mixing value at the determined offset position is now set at 0.

Accessing the Offset Function

1. Press the CHANNEL button once until offset appears in the center of the screen.
2. Place the master channel stick to the desired position of slave channel offset, then press either the INCREASE or DECREASE button to store.
3. Press the SCROLL button once to access the CCPM swashplate function.

4. To exit the Function mode, press the SCROLL and INCREASE buttons simultaneously.

Note: If a mix switch position other than on has been selected, it will be necessary to move the selected switch to the on or active position to set the offset value. "OF" will appear on the screen if the selected mixing switch is in the off position.

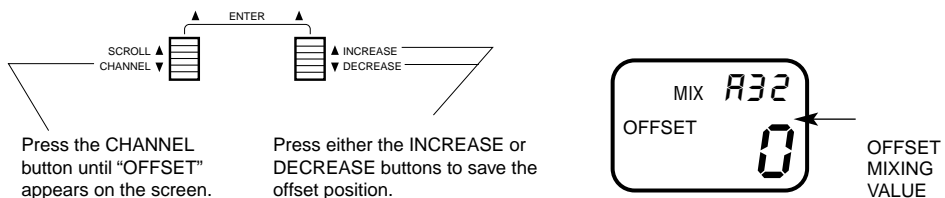

7.11

CCPM SWASHPLATE MIXING

The CCPM Swashplate Mixing function (Cyclic Collective Pitch Mixing) of the XP662 system is designed to allow the XP662 to be used in model helicopters that utilize a 120° CCPM-type swashplate control system. CCPM is a type of pitch mixing where

the three servos are connected directly to the swashplate of the helicopter and physically move both in unison and independently for all changes in pitch/cyclic. Please refer to the diagram below for proper 120° Three Servo-CCPM identification and connection.

Three-Servo (120 degrees) CCPM Mixing

Note: The CCPM Swashplate Mixing function is designed for use **only** with helicopters that incorporate the special 120° three-servo CCPM control system design. Use of the CCPM Function in a non-CCPM-equipped model can result in an uncontrollable condition.

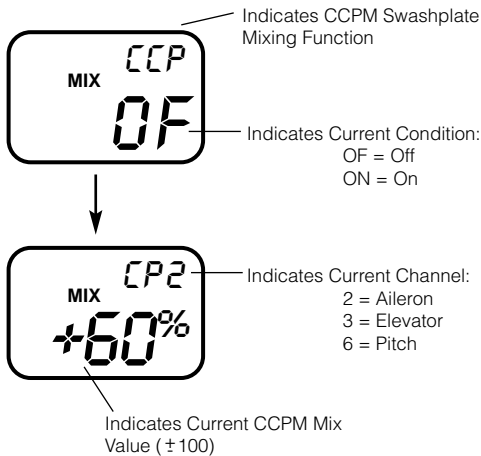
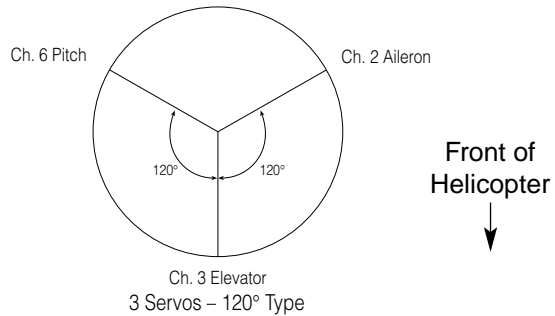

Please refer to the helicopter manufacturer's instructions for proper mixing values. Please also note that if control system interaction exists (pitch to aileron, pitch to elevator movement, etc.), it will be necessary to alter the travel adjust values for channels 2, 3, and 6 to correct this situation. Please refer to page 71 of this manual for further information.

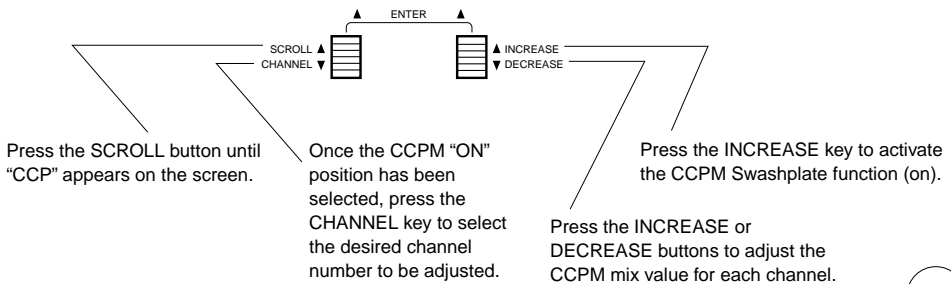

7.11 CCPM SWASHPLATE MIXING (continued)

Accessing the CCPM Swashplate Mixing Function

1. Turn on the transmitter.
2. Press the SCROLL and INCREASE buttons simultaneously to enter the function mode.
3. Press the SCROLL button until “CCP” appears on the screen.
4. Press the INCREASE button once to activate the CCPM Swashplate Mix function. The screen will then move to the “CP2” screen, indicating that the CCPM function is now on.
5. Press the CHANNEL button to select the desired channel number to be adjusted.
6. Press the INCREASE or DECREASE buttons to select the desired mixing value for each channel (± 100).
7. Press the SCROLL button once to access the servo reversing function.
8. To exit, press the SCROLL and INCREASE buttons simultaneously.

7.12 CCPM SERVO CONNECTIONS

The 120° CCPM system requires the use of three servos to operate, Aileron, Elevator, and AUX 1 (Pitch). The labeling of these servos can become quite confusing because with the CCPM function, the three servos no longer work independently, but rather as a team, and their functions are now combined. For this reason, we will refer to the three servos in the following manner:

Aileron Servo: We will refer to this servo as the “Left” servo. The channel number for this servo when using a JR radio is CH2.

Elevator Servo: We will refer to this servo as the “Front” servo. The channel number for this servo when using a JR radio is CH3.

AUX 1 (Pitch) Servo: We will refer to this servo as the “Right” servo. The channel number for this servo when using a JR radio is CH6.

Please refer to the CCPM connections chart below for clarification. For non-JR radios, please consult your radio instructions for proper connection.

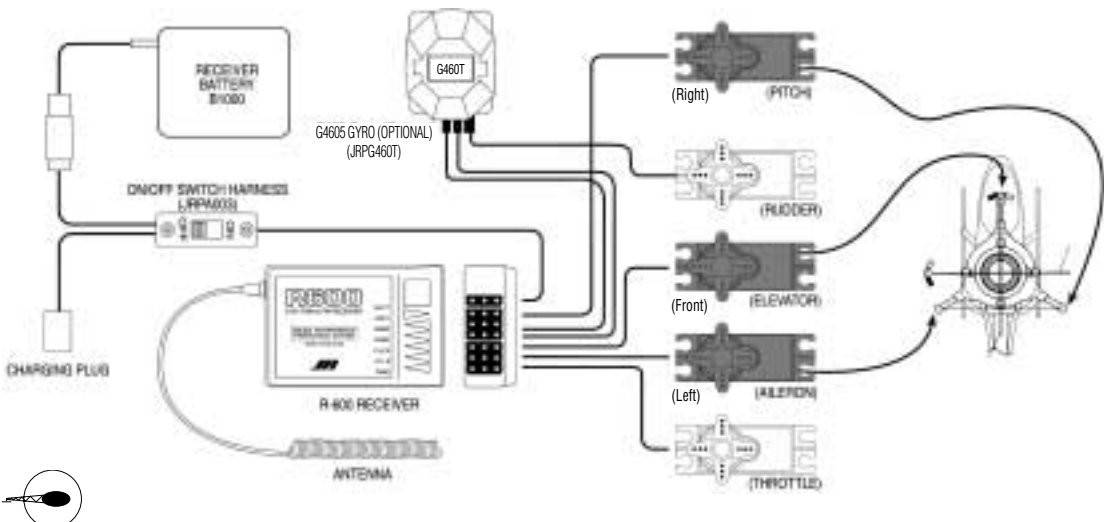

7.13 HOW 120° CCPM WORKS

As mentioned previously, 120° Three-Servo CCPM relies on the radio's special CCPM swashplate mixing, rather than a conventional mechanical mixer that is utilized to achieve the same results.

The radio's 120° Three-Servo CCPM function automatically mixes the three servos to provide the correct mixing inputs for aileron (roll), elevator (pitch), and collective. The following is an example of how each control input affects the servo's movement:

1. Collective

When a collective pitch input is given, all three servos (A, B, and C) move together in the same direction, at equal amounts, to raise and lower the swashplate while keeping the swashplate level. During this function, all three servos travel at the same value (100%) so that the swashplate can remain level during the increase and decrease in pitch. As mentioned, this mixing of the three servos is achieved through the radio's CCPM program.

2. Elevator (Pitch)

When an elevator input is given, all three servos must move to tilt the swashplate fore and aft, but their directions vary. The two rear servos (B and C) move together in the same direction, while the front servo (A) moves in the opposite direction. For example, when an up elevator (back cyclic) command is given, the two rear servos (B and C) will move downward, while the front servo (A) moves upward so that the swashplate will tilt aft. During this function, the front servo (A) travels at 100%, while the two rear servos (B and C) travel at 50% (1/2 the travel value) of the front servo. This difference in travel is necessary due to the fact that the position of the front control ball is two times the distance of the two rear control ball position as measured from the center of the swashplate. As mentioned, this mixing of the three servos is also achieved through the radio's CCPM program.

3. Aileron (Roll)

When an aileron (roll) input is given, the two rear servos (B and C) travel in opposite directions, while the front servo (A) remains motionless. For example, when a left aileron (roll) command is given, the left rear servo (C) will move downward, while the right rear servo (B) will move upward to tilt the swashplate to the left. As mentioned, the front servo (A) will remain motionless. The travel value for each of the two rear servos is 100%.

Please refer to the diagram below for clarification.

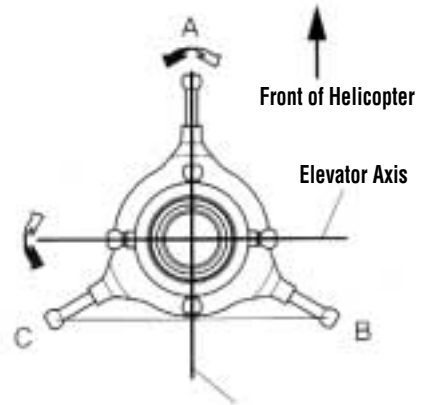

120° CCPM Control System



7.13 HOW 120° CCPM WORKS (continued)

120 Three-Servo CCPM Swashplate Mixing

The JR 120° CCPM or Cyclic/Collective Pitch Mixing system offers the user a control system that can accomplish the same control inputs as the One-Servo Standard system, but with increased precision and reduced complexity.

As with the One-Servo system, the JR CCPM system utilizes three servos for the three main controls: aileron (roll), elevator (pitch) and collective. The CCPM lower swashplate ring is designed with only three control balls, spaced at 120° from each other, hence the 120° CCPM designation. Although the control balls are not at 90° as in the standard system, the aileron (roll) axis is still parallel to the main mechanics of the helicopter, and the elevator (pitch) axis still functions at 90° to the mechanics as does the One-Servo System. Please refer to the diagram below for clarification.

The main and important difference in the way that these two systems operate is that unlike the One-Servo system where the three servos work completely independent from each other, the CCPM systems work as a team to achieve the same control inputs. For example, if an aileron (roll) input is given, two servos work together to move the swashplate left and right. If an elevator (pitch) input is given, all three servos work together to move the swashplate fore and aft. For collective, it's also the strength of three servos that will move the swashplate up and down the main rotor shaft. With two to three servos working at the same time during any given control input, servo torque is maximized and servo centering is also increased. In addition to these benefits, CCPM achieves these control responses without the need for complex mechanical mixing systems that require many more control rods and parts to set up.

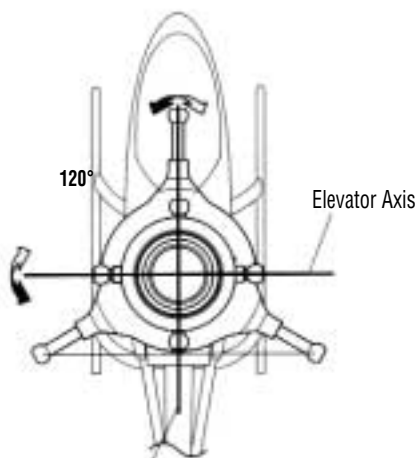

Aileron Axis
120° Three-Servo CCPM Control System

This amazing CCPM control is achieved through special CCPM Swashplate Mixing that is pre-programmed into many of today's popular radio systems.

Since the 120° CCPM function is pre-programmed, CCPM is no more complicated to set up than a conventional One-Servo Standard system. When you factor in the reduced parts count and easy programming, CCPM is actually easier to set up and operate than many conventional systems.



8

Data Sheet

Modulation S-PCM • Z-PCM • PPM (FM)

Model Number _____

Model Name _____

| CHANNEL | THR (1) | AIL (2) | ELE (3) | RUD (4) | GER (5) | PITCH (6) |
|-----------------------------|------------------|------------------|------------------|------------------|------------------|------------------|
| * REVERSE SW | NORM • REV | NORM • REV | NORM • REV | NORM • REV | NORM • REV | NORM • REV |
| SUB-TRIM | | | | | | |
| TRAVEL ADJUST (TRV ADJ.) | + % | + % | + % | + % | + % | + % |
| | - % | - % | - % | - % | - % | - % |
| FAIL-SAFE (S-PCM) | | | | | | |

| | |
|------------------------|--|
| FAIL-SAFE TIME (Z-PCM) | |
|------------------------|--|

| | |
|--------|-----------------|
| D/R SW | EA • A • E • CF |
|--------|-----------------|

| | |
|---------|---------------|
| GEAR SW | F • H • A • E |
|---------|---------------|

| THRO HOLD (HLD) | ON | OF | POSITION |
|-----------------|----|----|----------|
| | | | ± |

| | | | |
|---------------|---|----------|---|
| REVO-MIX (RV) | + | UP (U) | % |
| | - | DOWN (D) | % |

| CCPM MIXING | | ON • OFF | |
|-------------|---------|-----------|--|
| AIL (2) | ELE (3) | PITCH (6) | |
| + % | + % | + % | |
| - % | - % | - % | |

| | | AIL (AI) | ELEV (EL) |
|-----------|-------|----------|-----------|
| DUAL RATE | POS 0 | D/R | % |
| | | EXP | % |
| • EXP | POS 1 | D/R | % |
| | | EXP | % |

| | | L | 2 | H |
|-------------------------------|---|---|---|---|
| THRO CURVE TLN, T2N, THN, | N | % | % | % |
| TLS, T2S | S | % | % | % |
| PITCH CURVE PLN, P2N, PHN, | N | | | |
| PLS, P2S, PHS, | S | | | |
| PLH, P2H, PHH | H | | | |

| | | CHANNEL MASTER SLAVE | MIX SWITCH | OFFSET | +GAIN | -GAIN |
|-----------|---|----------------------------|------------------|--------|-------|-------|
| PROG. MIX | A | → | ON • F1 • F0 • H | | | |



1

GENERAL NOTES

Radio controlled models are a great source of pleasure. Unfortunately, they can also pose a potential hazard if not maintained and operated properly. It is imperative that you install your radio control system correctly. Additionally, your level of piloting competency must be high enough to ensure that you are able to control your aircraft under all conditions. If you are a newcomer to radio controlled flying, please seek help from an experienced pilot or your local hobby shop.

Listed below are some safety **Dos and Don'ts** that must be followed by all pilots:

- Ensure that your batteries have been properly charged prior to initial flight.
- Keep track of the time that the system is turned on so that you will have an idea of how long you can safely operate your system.
- Perform a ground range check prior to the initial flight of the day. See the "Daily Flight Checks" section below for information on how to do so.
- Check all control surfaces prior to each takeoff.
- Use frequency flags.
- Do not fly your model near spectators, parking areas, or at any other area that could result in injury to people or damage of property.
- Do not fly during adverse weather conditions. Poor visibility can cause disorientation and loss of control of your aircraft. Strong winds can cause similar problems.
- Do not fly unless your frequency is clear.
Warning: Only one transmitter at a time can operate on a given frequency. If you turn on your transmitter while someone else is operating a model on your frequency, both pilots will lose control of their models. Only one person can use a given frequency at a time. It does not matter if it is AM, FM, or PCM—**only one frequency at a time.**
- Do not point the transmitter antenna directly toward the model. The radiation pattern from the tip of the antenna is inherently low.
- Do not take chances. If at any time during flight you observe any erratic or abnormal operation, land immediately and do not resume flight until the cause of the problem has been ascertained and corrected.

2

DAILY FLIGHT CHECKS

1. Check the battery voltage on both the transmitter and the receiver battery packs. Do not fly below 9.0 volts on the transmitter or below 4.7 volts on the receiver. To do so can cause a crash of your aircraft.

Note: When you check these batteries, ensure that you have the polarities correct on your expanded scale voltmeter.

2. Check all hardware (linkages, screws, nuts, bolts) prior to each day's flight. Be sure that binding does not occur and that everything is properly secured.
3. Ensure that all surfaces are moving in the proper manner.
4. Perform a ground range check before each day's flying session. The range check should be as follows:
 - Do not extend the transmitter antenna at this time. Turn the transmitter on.
 - Turn the model on.
 - Slowly walk away from the model while moving the control surfaces. The aircraft should function properly at a distance of 75 to 100 feet.
5. Prior to starting your aircraft, turn off your transmitter then turn it back on. Do this each time you start your aircraft. If any critical switches are on without your knowledge, the transmitter alarm will warn you.
6. Ensure that all trim levers are in the proper location.
7. Be sure that all servo pigtails and switch harness plugs are secured in the receiver. Make sure that the switch harness moves completely in both directions.

IMPORTANT INFORMATION

3

WARRANTY COVERAGE

Your new equipment is warranted to the original purchaser against manufacturer defects in material and workmanship for one year from the date of purchase. During this period, Horizon Service Center will repair or replace, at our discretion, any component that is found to be factory defective at no cost to the purchaser. This warranty is limited to the original purchaser of the unit and is not transferable.

This warranty does not apply to any unit which has been improperly installed, mishandled, abused, or

damaged in a crash, or to any unit which has been repaired or altered by any unauthorized agencies. Under no circumstances will the buyer be entitled to consequential or incidental damages. This limited warranty gives you specific legal rights; you also have other rights which may vary from state to state. As with all fine electronic equipment, do not subject your unit to extreme temperatures, humidity or moisture. Do not leave it in direct sunlight for long periods of time.

4

REPAIR SERVICE INSTRUCTIONS

In the event that your equipment needs service, please follow the instructions listed below:

1. Check all on/off switches to be sure they are off. This will speed the repair process of checking battery condition.
2. Return your system components only (transmitter, receiver, servos, etc.). Do not return your system installed in a model car, boat, plane, etc.
3. Use the original carton/packaging (molded foam container), or equivalent, to ship your unit. Do not use the carton itself as a shipping carton; you should package the equipment carton within a sturdy shipping container using additional packing material to safeguard against damage during transit. Include complete name and address information inside the carton, as well as clearly writing it on the outer label/return address area. Ship your equipment fully insured and prepaid. Horizon Service Center is not responsible for any damages incurred during shipping.
4. Include detailed information explaining your operation of the equipment and problem(s) encountered. Provide an itemized list of equipment enclosed and identify any particular area/function

which may better assist our technicians in addressing your concerns. Date your correspondence and include your name, mailing address, and a phone number where you can be reached during the business day.

5. **Warranty Repairs.** To receive warranty service you must include a legible photocopy of your original dated sales receipt to verify your proof-of-purchase date. Providing that warranty conditions have been met, your radio will be repaired without charge.
6. **Normal Non-Warranty Repairs.** Should your repair cost exceed 50% of the retail purchase cost, you will be provided with an estimate advising you of your options.

Within your letter, advise us of the payment method you prefer to use. Horizon Service Center accepts VISA or MasterCard, please include your card number and expiration date.

Mail your system to:

Horizon Service Center
4105 Fieldstone Road
Champaign, Illinois 61822
(217) 355-9511
www.horizonhobby.com

IMPORTANT INFORMATION

5

FREQUENCY CHART

72MHz requires no special license to operate.

50MHz requires the operator to have an FCC amateur radio license (Ham).

| 72MHz | | 72MHz | | 50MHz | |
|--------|-----------|--------|-----------|--------|-----------|
| CH.NO. | FREQUENCY | CH.NO. | FREQUENCY | CH.NO. | FREQUENCY |
| 15 | 72.090 | 36 | 72.510 | 00 | 50.800 |
| 16 | 72.110 | 37 | 72.530 | 01 | 50.820 |
| 17 | 72.130 | 38 | 72.550 | 02 | 50.840 |
| 18 | 72.150 | 39 | 72.570 | 03 | 50.860 |
| 19 | 72.170 | 40 | 72.590 | 04 | 50.880 |
| 20 | 72.190 | 41 | 72.610 | 05 | 50.900 |
| 21 | 72.210 | 42 | 72.630 | 06 | 50.920 |
| 22 | 72.230 | 43 | 72.650 | 07 | 50.940 |
| 23 | 72.250 | 44 | 72.670 | 08 | 50.960 |
| 24 | 72.270 | 45 | 72.690 | 09 | 50.980 |
| 25 | 72.290 | 46 | 72.710 | | |
| 26 | 72.310 | 47 | 72.730 | | |
| 27 | 72.330 | 48 | 72.750 | | |
| 28 | 72.350 | 49 | 72.770 | | |
| 29 | 72.370 | 50 | 72.790 | | |
| 30 | 72.390 | 51 | 72.810 | | |
| 31 | 72.410 | 52 | 72.830 | | |
| 32 | 72.430 | 53 | 72.850 | | |
| 33 | 72.450 | 54 | 72.870 | | |
| 34 | 72.470 | 55 | 72.890 | | |
| 35 | 72.490 | 56 | 72.910 | | |
| | | 57 | 72.930 | | |
| | | 58 | 72.950 | | |
| | | 59 | 72.970 | | |
| | | 60 | 72.990 | | |

***Channels 11–14 are not available**

Transmitter Crystal Replacement Notice

The Federal Communications Commission (FCC) requires that changes in transmitter frequency must be performed only by an authorized service technician (Horizon Service Center). Any transmitter frequency change made by non-certified technician may result in a violation of the FCC rules.



Distributed exclusively by Horizon Hobby, Inc. Champaign, IL 61822
www.horizonhobby.com
© 2002 Horizon Hobby, Inc.